

---

---

**Air Defense Artillery  
Reference Handbook**

---

---

**October 2007**

**DISTRIBUTION RESTRICTION.** Distribution authorized to U.S. Government agencies and their contractors only to protect technical information. This determination was made on 22 March 2006. Other requests for this document must be referred to Commandant, United States Army Air Defense Artillery School, ATTN: ATSA-DT-DTR, Fort Bliss, TX 79916-3802.

**DESTRUCTION NOTICE.** Destroy by any method that will prevent disclosure of contents or reconstruction of the document.

---

---

**Headquarters, Department of the Army**

---

---

This publication is available at  
Army Knowledge Online ([www.us.army.mil](http://www.us.army.mil)) and  
General Dennis J. Reimer Training and Doctrine  
Digital Library at ([www.train.army.mil](http://www.train.army.mil)).

# Air Defense Artillery Reference Handbook

## Contents

	<b>Page</b>
<b>PREFACE</b> .....	<b>v</b>
<b>INTRODUCTION</b> .....	<b>vi</b>
Air Defense Artillery Mission .....	vi
Air and Missile Defense Mission .....	vi
Geopolitical Assets .....	vi
Threat .....	vi
Air and Missile Defense Operations .....	vii
<b>Chapter 1 AVENGER</b> .....	<b>1-1</b>
Mission .....	1-1
Avenger .....	1-1
Stinger .....	1-4
<b>Chapter 2 PATRIOT</b> .....	<b>2-1</b>
Mission .....	2-1
Role .....	2-1
Threat During Lodgment Entry Operations .....	2-1
Physical Description of Major Items .....	2-2
<b>Chapter 3 TERMINAL HIGH-ALTITUDE AREA DEFENSE</b> .....	<b>3-1</b>
Mission .....	3-1
General Trajectory Phases .....	3-1
Battery Components .....	3-3

---

**DISTRIBUTION RESTRICTION.** Distribution authorized to U.S. Government agencies and their contractors only to protect technical information. This determination was made on 22 March 2006. Other requests for this document must be referred to Commandant, United States Army Air Defense Artillery School, ATTN: ATSA-DT-DTR, Fort Bliss, TX 79916-3802.

**DESTRUCTION NOTICE.** Destroy by any method that will prevent disclosure of contents or reconstruction of the document.

**\*This publication supersedes FM 3-01.11, 31 October 2000.**

<b>Chapter 4</b>	<b>ADA COMPOSITE BATTALION</b> .....	<b>4-1</b>
	Mission .....	4-1
	ADA Planning Overview.....	4-4
	ADA Task Force Operations.....	4-4
	ADA Fire Control Officer .....	4-8
<b>Appendix A</b>	<b>SENTINEL RADAR SYSTEMS</b> .....	<b>A-1</b>
	Mission .....	A-1
	Description .....	A-1
	Methods of Employment (A and B).....	A-3
	Improved Sentinel Radar Sensor.....	A-4
<b>Appendix B</b>	<b>AIR DEFENSE AND AIRSPACE MANAGEMENT CELL</b> .....	<b>B-1</b>
	Mission .....	B-1
	Role .....	B-1
	Augmentation .....	B-1
	Reach.....	B-2
	Enhanced Situational Understanding .....	B-3
	Joint, Interagency, and Multinational Interoperability .....	B-3
	Full Spectrum Operations .....	B-4
	ADAM Cell Equipment .....	B-4
<b>Appendix C</b>	<b>TRAINING DEVICES AND AERIAL TARGETS</b> .....	<b>C-1</b>
	Training Devices .....	C-1
	Aerial Targets.....	C-9
	<b>GLOSSARY</b> .....	<b>Glossary-1</b>
	<b>Section 1 — Acronyms and Abbreviations</b> .....	<b>Glossary-1</b>
	<b>Section II — Terms</b> .....	<b>Glossary-7</b>
	<b>REFERENCES</b> .....	<b>References-1</b>
	<b>INDEX</b> .....	<b>Index-1</b>

## Figures

Figure 1-1.	Avenger primary components .....	1-2
Figure 1-2.	Gunner's station .....	1-3
Figure 1-3.	Stinger MANPADS .....	1-5
Figure 1-4.	Stinger RMP/Block1 .....	1-5
Figure 1-5.	Stinger missile components .....	1-7
Figure 1-6.	Stinger launch tube assembly .....	1-7
Figure 1-7.	Stinger RMP gripstock .....	1-8
Figure 1-8.	Stinger RMP/Block1 gripstock.....	1-8
Figure 1-9.	Stinger BCU top view .....	1-9
Figure 1-10.	Stinger BCU base .....	1-9
Figure 1-11.	Stinger IFF antenna and interrogator subsystem .....	1-10
Figure 1-12.	Stinger IFF AN/GSX-1 interrogator system support equipment.....	1-11

Figure 1-13. AN/GSX-1A, KIR-1C/TSEC, and KOI-18/TSEC ..... 1-11

Figure 1-14. Stinger weapon-round metal shipping and storage container ..... 1-12

Figure 1-15. Stinger missile-round wooden shipping and storage container ..... 1-12

Figure 2-1. Electric power plant III ..... 2-2

Figure 2-2. Information and coordination central ..... 2-3

Figure 2-3. Tactical command system with 15-kw generator ..... 2-4

Figure 2-4. Communications relay group with EPU ..... 2-4

Figure 2-5. Engagement control station ..... 2-5

Figure 2-6. Battery command post ..... 2-6

Figure 2-7. Radar set ..... 2-6

Figure 2-8. Patriot PAC-2 or PAC-3 LS (emplaced) ..... 2-7

Figure 2-9. Antenna mast group ..... 2-8

Figure 2-10. Patriot missiles ..... 2-9

Figure 2-11. Patriot support equipment ..... 2-11

Figure 3-1. General trajectory phase segments ..... 3-2

Figure 3-2. Terminal phase defense segment ..... 3-3

Figure 3-3. THAAD fire control and communications ..... 3-4

Figure 3-4. THAAD transporter and missile-round pallet ..... 3-5

Figure 3-5. Block 08 configuration missile-round ..... 3-6

Figure 3-6. THAAD radar components ..... 3-7

Figure 3-7. THAAD battery support center ..... 3-8

Figure 3-8. Interim contractor support system ..... 3-8

Figure 4-1. ADA composite battalion organization (example) ..... 4-2

Figure 4-2. ADA composite battalion HHB (example) ..... 4-2

Figure 4-3. ADA composite battalion Patriot battery (example) ..... 4-3

Figure 4-4. ADA composite battalion Avenger battery (example) ..... 4-3

Figure 4-5. ADATF organization (example) ..... 4-4

Figure 4-6. ADATF defense design considerations (example) ..... 4-5

Figure 4-7. ADATF communications networks ..... 4-6

Figure 4-8. JDN, JECN, and JMMN ..... 4-7

Figure 4-9. Mobile subscriber equipment and voice nets ..... 4-7

Figure A-1. Sentinel radar sensor system ..... A-2

Figure A-2. Improved Sentinel, AN/MPQ-64A1 ..... A-5

Figure B-1. ADAM cell interoperability ..... B-3

Figure B-2. ADAM cell ..... B-4

Figure B-3. Roadside equipment in CPP ADAM cell ..... B-5

Figure B-4. Curbside equipment in the CPP ADAM cell ..... B-6

Figure B-5. ADAM cell remotored from shelter ..... B-8

Figure C-1. Stinger tracking head trainer ..... C-3

Figure C-2. Improved moving target simulator ..... C-4

Figure C-3. THAAD Block 06 TADSS ..... C-7

Figure C-4. User system operator trainer..... C-8

## **Tables**

Table 1. STANAGs..... v

Table 2-1. Patriot tactical equipment weights and dimensions ..... 2-11

Table 2-1. Patriot tactical equipment weights and dimensions (continued)..... 2-12

Table 2-1. Patriot tactical equipment weights and dimensions (continued)..... 2-13

Table A-1. Sentinel characteristics ..... A-3

Table B-1. AN/TSQ-282 system capabilities, linkages, and enabling device..... B-7

Table C-1. Drone targets..... C-10

Table C-2. Towed targets..... C-10

Table C-3. Ballistic target..... C-11

# Preface

The purpose of this field manual (FM) is to familiarize personnel with air defense artillery (ADA) operations and weapon systems and their roles in air and missile defense (AMD). This publication is intended for personnel serving in the following positions:

- Staff positions requiring general knowledge of ADA systems and operations.
- Instructor positions in service schools and the Reserve Officer Training Corps.
- Members of advisory elements and groups assigned to missions in foreign countries.
- Advisory positions in reserve component forces.
- Command and leadership positions in special operations force units.
- Executive positions and advisory positions that require knowledge of air defense subjects.

Readers are reminded that weapon systems and operations are continually changing. Publications such as interactive electronic technical manuals, table(s) of organization and equipment (TOE), and mission training plans provide more detailed information on specific subjects. Many of these sources are referred to in appropriate sections of this FM.

This publication implements the standardization agreements (STANAGs) listed in Table 1 in compliance with the multinational force compatibility.

**Table 1. STANAGs**

<b>Number</b>	<b>Title</b>	<b>Edition</b>
3700	Joint Air and Space Operations Doctrine—AJP-3.3	6
3805	Doctrine for Joint Airspace Control—AJP-3.3.5(A)	8
3880	Counter Air—AJP-3.3.1(A)	5

This publication applies to the Active Army, the Army National Guard/Army National Guard of the United States, and the United States Army Reserve unless otherwise stated. The proponent for this manual is the United States Army Training and Doctrine Command (TRADOC). Send comments and recommendations on DA Form 2028 (*Recommended Changes to Publications and Blank Forms*) to Commandant, U.S. Army Air Defense Artillery School (USAADASCH), ATTN: ATSA-DT-DTR, Fort Bliss, TX 79916-3802.

Unless this publication states otherwise, masculine nouns and pronouns do not refer exclusively to men.

# Introduction

## AIR DEFENSE ARTILLERY MISSION

The mission of U.S. Army ADA is to protect the force and selected geopolitical assets from aerial attack, missile attack, and surveillance using AMD mission sets. The four mission sets are—

- Provide AMD.
- Contribute to situational awareness/situational understanding (SA/SU).
- Contribute to Airspace Command and Control (AC<sup>2</sup>).
- Contribute to operational protection.

## AIR AND MISSILE DEFENSE MISSION

Army ADA forces, fighting interdependently with other elements of the joint, interagency, and multinational (JIM) team at strategic, operational, and tactical levels, provide critical air and missile defense. They also contribute to SA and SU, airspace management, and operational force protection to deter or defeat enemy aerial threats, protect the force and high-value assets, enable freedom to maneuver, and contribute to victory.

The four elements of the AMD mission statement—Dominate, Enable, Exploit, and Protect—have specific meanings within the context of Army ADA. These elements are imperative to focus on ADA transformation for the future. The Dominate-Enable-Exploit-Protect cycle contributes synergistically to support JIM operations. Army ADA transformation will address capability gaps as part of a larger joint AMD transformation effort.

ADA commanders allocate active and reserve air defense (AD) component assets based on the supported commander's priorities. The mission is designed to include protection of critical assets, installations, and facilities along with the joint and multinational forces when required.

## GEOPOLITICAL ASSETS

Geopolitical assets are nonmilitary assets that U.S., allied, or host nation civil authorities nominate for AMD protection. These assets can be political, religious, ethnic, historical, or territorial in nature. Since protection of geopolitical assets may not directly support military operations, the integration of geopolitical assets into the AMD priorities list must be accomplished at the highest levels.

## THREAT

The evolving AMD threat will take on new characteristics. The major threat to deployed U.S. forces will continue to be that of regional powers as they seek to dominate their respective regions. Adversaries will continue to closely observe emerging U.S. capabilities in an effort to identify and exploit weaknesses using asymmetric approaches. Chemical, biological, radiological, and nuclear (CBRN) weapons proliferation and their delivery means (particularly ballistic and cruise missiles [BMs and CMs]), stealth capabilities, and the employment of unmanned aircraft systems (UASs) will improve their military forces and the asymmetric options available to them when facing the U.S. and its allies and coalition partners.

Fundamental capabilities that adversaries may pursue to counter U.S. strengths include, but are not limited to, weapons of mass destruction, unmanned intelligence, surveillance, and reconnaissance (ISR) target acquisition platforms, UASs, large numbers of inexpensive rockets, low-observable cruise missiles, and information warfare. Some states may rely on asymmetric capabilities as a substitute for, or complement to, large conventional forces. Regional competition reinforces the perceived need to acquire unmanned systems that provide high operational effectiveness for nominal cost.



## **AIR AND MISSILE DEFENSE OPERATIONS**

AMD operations are inherently joint operations, multicomponent, and embody Army doctrine. ADA forces are versatile, agile, and fight throughout the depth of the theater of operations. Through aggressive planning and carefully coordinated execution of the plan, the ADA assets allow the commander at any level to seize and maintain the initiative. Commanders integrate AMD operations into campaigns fought at the operational and tactical engagement levels.

Successful AMD operations are the key to generating and sustaining combat power in force projection operations. The ADA contribution to friendly efforts to counter threat reconnaissance, surveillance, and target acquisition (RSTA) and identification efforts establishes a greater emphasis on current Army ADA capabilities. Both active and reserve components must synergistically combine with AD assets of other services to defeat the multifaceted threat. The Army AD forces participate in operations at all levels of war.

This FM describes ADA weapon systems currently in the force. Short-range air defense (SHORAD) weapons are employed in support of maneuver forces. They defend personnel and assets against attack by enemy aerial platforms. They are also employed to defend air bases, forces, key installation, and other vital assets. SHORAD weapon systems include Avenger and Stinger. The Patriot system is deployed to defend theater and corps commanders' assets. Patriot provides protection against airborne threats from very low to very high altitudes. The terminal high-altitude area defense (THAAD) system is also deployed to defend theater and corps commander's assets. THAAD serves as a high-altitude defense against BMs. It is capable of detecting and intercepting BM threats in and above the atmosphere.

Also described in this FM are the Sentinel radar sensor system, the air defense and airspace management (ADAM) cell, and the training devices and aerial targets used to train Soldiers to promote skills, knowledge, and expertise required to maintain their proficiency with the above-mentioned ADA systems.

**This page intentionally left blank.**

# Chapter 1

## Avenger

This chapter contains information on Avenger systems. The Avenger lightweight, highly mobile weapon system and the Stinger man-portable air defense system (MANPADS) are deployed in support of the force against close-in attack by hostile aircraft such as UASs and CMs. Avenger and MANPADS are also deployed to provide close-in air defense to combat elements, high-priority maneuver units, and high-priority critical assets. Stinger complements other ADA systems when priorities and situation permit.

### MISSION

1-1. The Avenger weapon system is designed to provide the force with low-altitude air defense against unmanned aircraft (UA), UASs, and CMs, denying the enemy an effective capability. Stinger MANPADS is shoulder-fired.

### AVENGER

1-2. Avenger is designed to counter low-altitude UA/UASs, high-speed fixed-wing (FW) and helicopter (rotary-wing [RW]) aircraft, missiles, and enemy RSTA. The Avenger is capable of firing basic or reprogrammable microprocessor (RMP)/Block1 versions. The electrically driven gyro-stabilized turret is mounted on the high-mobility, multipurpose, wheeled vehicle (HMMWV). The gunner can launch a Stinger missile or fire the machine gun while on-the-move or from the remote configuration via the remote control unit (RCU) outward 50 meters from the fire unit itself.

### PRIMARY COMPONENTS

1-3. Avenger is air transportable by C-5, C-17, or C-130 transport aircraft. The Avenger air defense weapon system is a highly mobile, lightweight, day or night, limited adverse weather, surface-to-air and gun weapon system platform mounted on the M1097 HMMWV. Each Avenger consists of a two-man crew and eight ready-to-fire Stinger missiles per gunner's station mounted in standard vehicle-mounted launchers (SVMLs), a belt-fed M3P .50-caliber machine gun; a sensor package with a forward-looking infrared (FLIR) receiver, and a digital fire control system. See Figure 1-1.

Contents	
Mission.....	1-1
Avenger.....	1-1
Stinger.....	1-4

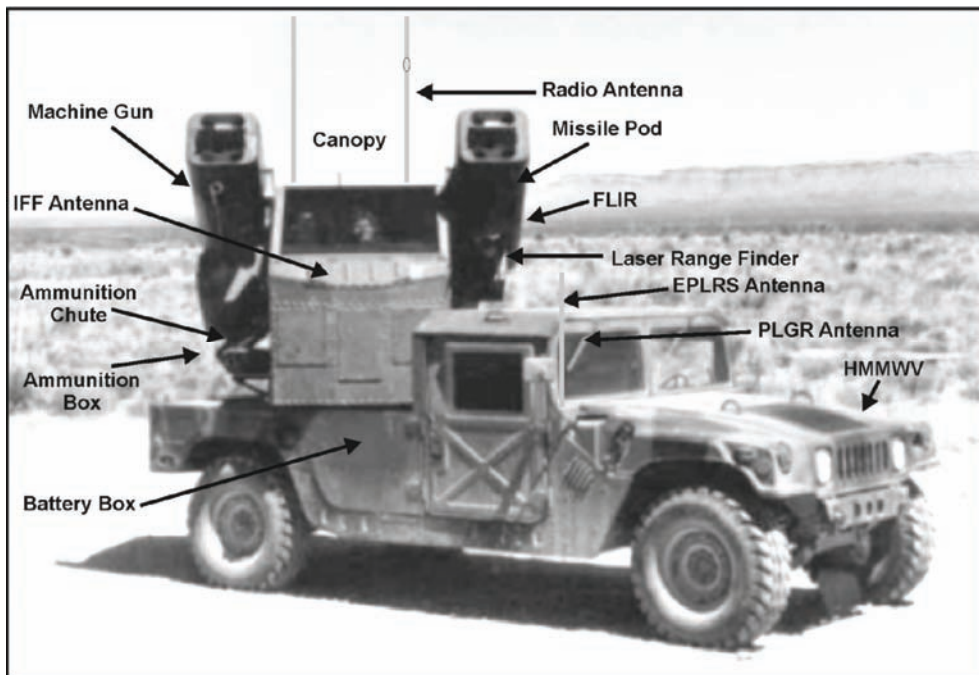

**Figure 1-1. Avenger primary components**

## AVENGER FIRING SEQUENCE

1-4. The Avenger firing sequence is entirely automated after the firing trigger is closed. The gunner, after receiving an “unknown” IFF response and visually identifying the target as hostile, activates a missile, uncages the seeker, and when the target is within range, fires. Immediately upon firing, the next missile is already cooled down and begins to spin up. This is done automatically without the gunner’s assistance. The Avenger has a unique backup capability while performing its mission. Should the Avenger become degraded, a missile-round is removed from a selected SVML pod, a gripstock attached to the missile-round, then fired in the MANPADS configuration. Gripstocks and battery coolant units (BCUs) are stored on-board the Avenger during combat missions.

## AVENGER ON-BOARD COMMUNICATIONS

1-5. The Avenger on-board communications equipment consists of the AN/PSQ-6 enhanced position location reporting system (EPLRS), AN/PSN-11 precision lightweight global positioning system (GPS) receiver (PLGR), RT-1439/VRC-91(A) receiver transmitter, AM 1780/VRC audio frequency amplifier, single-channel ground and airborne radio system (SINCGARS), CP-1995/U simplified handheld terminal unit (SHTU), combat vehicle crewman (CVC) helmet, C-2298/VRC control box, and the AS-1729/VRC antenna.

## TURRET GUNNER’S STATION

1-6. The turret gunner’s station incorporates an environmental control unit (ECU) that primarily consists of a make-up filter and prime power unit to provide the gunner a controlled environment and protection from chemical and biological hazards and unobstructed fields of fire. It can rotate through 360 degrees in azimuth and from -10 degrees to +68 degrees in elevation. One SVML pod is mounted on each side of the turret containing four Stinger missiles each. Missile reload time is 6 minutes or less. The turret gunner’s station is shown in Figure 1-2.

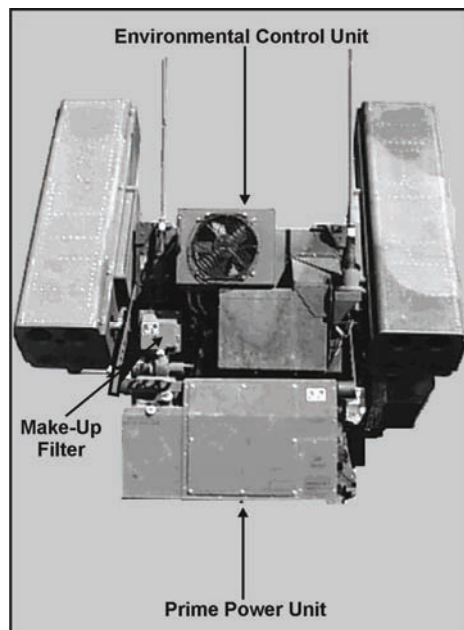

**Figure 1-2. Gunner's station**

1-7. The turret gunner's station is gyro-stabilized by a gyro attached to the turret floor which senses changes in azimuth (direction) of the HMMWV and provides error signals to the electronics control assembly to maintain continuous weapon pointing when in the stabilized mode.

1-8. The M3P .50-caliber machine gun is mounted on the right launch beam. It provides air defense coverage inside the missile's dead zone and provides for FU self-defense against hostile ground fire. Linked ammunition consisting of 200 rounds is fed to the gun via a flexible feed chute.

### REMOTE CONTROL UNIT

1-9. Using the RCU, the Avenger crew can operate the system remotely to a distance of 50 meters. The hand control switches and indicators on the RCU are the same as those found on the gunner's console, with the exception that no adjustments to the FLIR can be made from the RCU. As the environment or weather changes, it is critical the FLIR be kept properly adjusted at all times to ensure the RCU remains effective.

### SENSOR PACKAGE

1-10. The Avenger A1 is equipped with a sensor package for target acquisition. The package includes the FLIR, optical sight, IFF, and laser range finder (LRF). They are described below:

- **FLIR Receiver:** The FLIR system provides enhanced acquisition capability in various environments such as night, smoke, rain, background clutter, or haze conditions. Once the gunner has detected and acquired the target with FLIR, he may manually track the target using the hand station. Or the gunner may select the automatic video tracker (AVT) by pressing and releasing the right thumb switch on the hand station.
- **Optical Sight:** The optical sight is used to conduct a heads-up engagement. It allows the gunner to manually acquire targets through the canopy and to aim the missiles. The gunner will see the same symbology that appears on the FLIR monitor, but without the auto-track reticule and the narrow field of view fixed reticule.
- **IFF:** The IFF located on the Avenger system consists of the AN/PPX/3A/B and is activated by the gunner. This system allows the gunner to identify aircraft equipped with Mode 4 or Mode 3 programmed transponders as positive friend, possible friend, or unknown. In normal operation,

the IFF system located on-board the FU sends a coded interrogation signal to the unidentified aircraft. A reply is automatically generated and transmitted by the aircraft. Based on the IFF response and visual identification, the gunner will either continue the engagement sequence or opt to use search and scan procedures.

- LRF: Range data from the LRF is processed by the analysis control element computer and is displayed to the gunner on the control display terminal (CDT) in meters. The computer uses this range data to determine fire permit and lead angle information for missile and gun use. A fire permit symbol is not required to launch a missile; however, it is required to fire the machine gun in the air or ground (auto) mode.

1-11. The Avenger A2 is equipped with the LRF, FLIR, FLIR monitor, the Avenger fire control computer (AFCC), and the optical sight.

## **SLEW-TO-CUE SYSTEM**

1-12. The Avenger slew-to-cue receives data from forward area air defense (FAAD) command and control (C<sup>2</sup>) and intelligence activities. It processes and displays air track data to the driver and gunner, then automatically slews the turret to the selected target.

## **SENSITIVITY TIME CONTROL MAJOR COMPONENTS**

1-13. The AFCC provides for the sensitivity time control (STC) system integration and processing of all incoming data from the crew chief air situation display. It passes this information to the gunner via the targeting console. The STC system provides the gunner at the targeting console with information and controls necessary to engage in air combat. It includes a system target tracking window with appropriate symbology, system status menus, built-in-test (BIT) interface, and various other components.

1-14. The land navigation system (LNS) provides real-time headings and current positioning of the Avenger STC FU and supports the STC's ability to fire on-the-move while enhancing the necessity of "first-to-fire."

1-15. The cab interconnect panel was developed to simplify the cab wiring harness and provide the required power circuitry protection for devices in the vehicle cab.

1-16. The slip ring contains other high current conductive rings alternately stacked with insulation rings to allow the transmission of power and other electrical signals between the stationary and rotating segments of the turret. The slip ring has been modified to include two additional connectors to support slew-to-cue.

1-17. The CDT displays essential operational information and allows direct interface with the RCU during remote operations. The CDT operations are converted to LNS during normal operations.

1-18. The handheld terminal unit (HTU)/crew chief air situation display is a small computer terminal used to receive, process, and display messages and data to accomplish operational function using the handheld communications subsystem. The HTU is compatible with SINCGARS communications and is ported for EPLRS support. However, the forward area computer terminal is replacing the HTU.

## **STINGER**

1-19. MANPADS shoulder-fired configuration is primarily used as a backup should the Avenger vehicle or turret system malfunction (Figure 1-3). Stinger can be converted to the shoulder-fired configuration by removing a missile-round from one of its two Avenger missile pods. A gripstock and BCU is then attached to the launch tube and Stinger becomes a ready-weapon allowing it to be employed as a backup weapon should the Avenger fire unit (FU) become degraded.



**Figure 1-3. Stinger MANPADS**

1-20. The Stinger weapon system is fielded in two versions—the Stinger RMP version with its increased improvements to the guidance section and increased capability to reject complex infrared countermeasures (IRCMs), and the reprogrammable capability to meet the ever-changing threat without hardware redesign or replacement. The RMP version is now being used exclusively by USAADASCH for student training and qualification until all missiles are exhausted. However, all units are being fielded with Stinger RMP/Block1 shown in Figure 1-4. Stinger RMP/Block1 version combines RMP and incorporates refinements to the guidance system electronics. This upgrade provides the capability for the missile to determine its “up” position during launch sequence. This allows the missile to bias its flight to counteract gravitational forces and enhance missile performance in non-ideal scenarios, such as minimum target elevation angles and low-target aspect angles in a clutter environment. The Stinger RMP/Block1 missile is a heat-seeking guided missile that tracks to the target in the infrared/negative ultraviolet (IR/NUV) spectrums through proportional navigation. After firing, the gunner has no control over the missile and is required only to observe the missile’s flight trajectory (path) to the target or opt to reengage another target. Stinger incorporates an identification, friend or foe (IFF) interrogator system that assists the gunner and team chief in identifying aircraft as “positive friend,” “possible friend,” or “unknown.” The final decision to launch is always based on positive visual identification of the aircraft as “hostile.” Tactical weight of the Stinger weapon-round with gripstock attached and BCU installed is 36.1 pounds. The weapon-round is readily identified by four yellow, 1-inch squares located at each end of the launch tube and BCU receptacle.

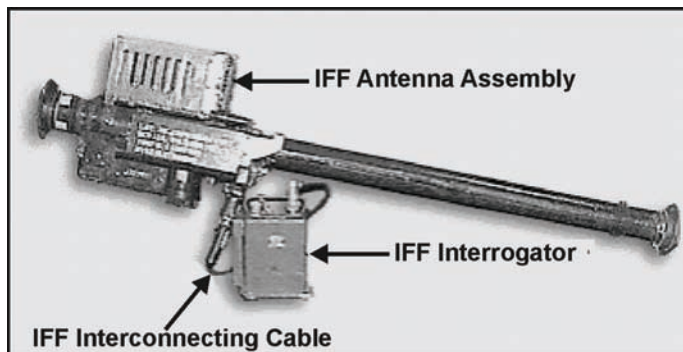

**Figure 1-4. Stinger RMP/Block1**

1-21. Components that make up the Stinger weapon-round are: a missile housed in a fiberglass launch tube; a permanently attached hinged open sight assembly located atop the fiberglass launch tube; a gripstock with an IFF antenna, and a BCU installed. To assist the gunner in aircraft identification, the IFF antenna is unfolded and the IFF interconnecting cable is connected beneath the firing trigger handgrip. Interrogation function is accomplished by pressing the IFF interrogate switch located at the rear of the gripstock. Stinger is a “fire-and-forget” system. This means that immediately after firing, the gunner removes and discards the BCU from its receptacle, folds and stows the IFF antenna, unlatches the latch mechanism located at the forward end of the gripstock, and removes the gripstock from the launch tube. The launch tube is then discarded by various means of destruction such as crushing explosives or fire. The gunner can now ready another missile-round for engagement or opt to seek cover after launch. The gripstock is reused continually until failure. System self-containment capability is provided by an on-board power and coolant supply source to power the missile during the prelaunch engagement phase. At trigger closure, the on-board missile battery and argon coolant supply are enabled throughout the terminal flight phase to the target. The RMP/Block1 improvement program extends the missile’s service life, while providing improved accuracy and resistance to countermeasures, increased effectiveness against near-term low-observable targets, and UA/UASs, CMs, and standoff helicopters in a clutter environment. The need for superelevation eliminates a situation which would create a safety hazard when configured to launch from a hovering helicopter.

## MISSILE COMPONENTS

1-22. Figure 1-5 shows the Stinger missile and its components. The main components are as described below:

- **Guidance section.** The guidance section consists of the control surfaces assembly, on-board argon gas for in-flight seeker head coolant, missile battery for in-flight power, and four spring-loaded, deployable control surfaces for guidance. The guidance section processes target IR/NUV and provides guidance commands to the missile during flight. Once the missile is launched, it continues to track the IR/NUV source while the control assembly continues to receive, process, and translate the guidance signals from the seeker. These signals are then converted to guidance commands which provide for missile control surface movement.
- **Warhead section.** The warhead section consists of a fuze assembly and a quantity of explosives. Once the flight motor ignites, the fuze arms the warhead during its terminal flight phase. The fuze will detonate the warhead in one of three ways—(1) low-impact switch, (2) hard-target sensing, or (3) self-destruct if target intercept does not occur after approximately 15 to 19 seconds.
- **Propulsion section.** The propulsion section is provided by the launch/eject motor and the dual-thrust (boost and sustain phase) solid propellant flight motor. The launch/eject motor ejects the missile to approximately 28 feet from the launch point, allowing the missile to coast a safe distance prior to flight motor ignition. Once expended, the launch/eject motor separates from the flight motor. A lanyard is attached between the launch/eject motor and the flight motor. As the launch/eject motor separates, the lanyard pulls the shorting plug from the flight motor, initiating ignition a safe distance from the gunner.



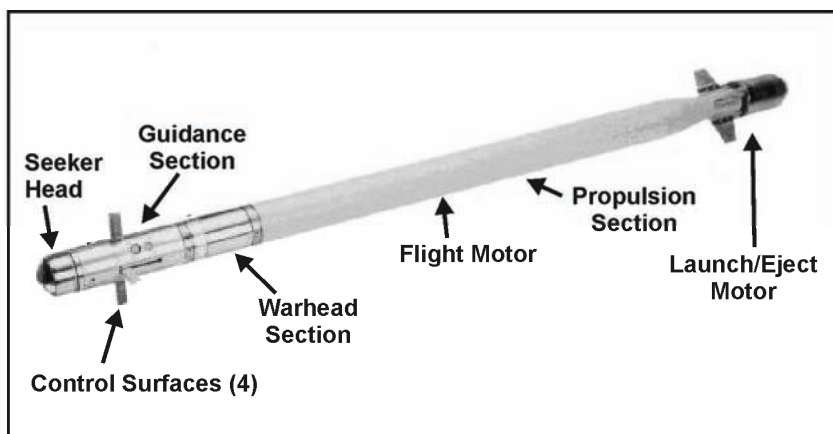

Figure 1-5. Stinger missile components

### LAUNCH TUBE ASSEMBLY

1-23. The Stinger launch tube assembly provides the means to transport, aim, and launch the missile. The Stinger launch tube is the primary support assembly for all other components that convert it to a weapon-round. Both ends of the launch tube are environmentally sealed with breakable disks. The forward end of the sealed launch tube has an IR window which allows radiation to reach the heat-sensitive missile seeker. At launch, the front and aft disks break outward as the launch eject motor ignites and missile movement occurs. A cylindrical-shaped, replaceable desiccant cartridge, located atop the launch tube indicates the presence of moisture, if any. The hinged open-sight assembly attached to the launch tube allows the gunner to sight, determine range, determine when to superelevate the weapon, and to hear the audible tones produced through the acquisition indicators—cheek-to-bone transducer (IR/NUV lock-on) and speaker (IFF interrogator). The eyeshield attached to the sight frame protects the gunner's left eye during missile launch. Figure 1-6 shows the Stinger launch tube assembly.

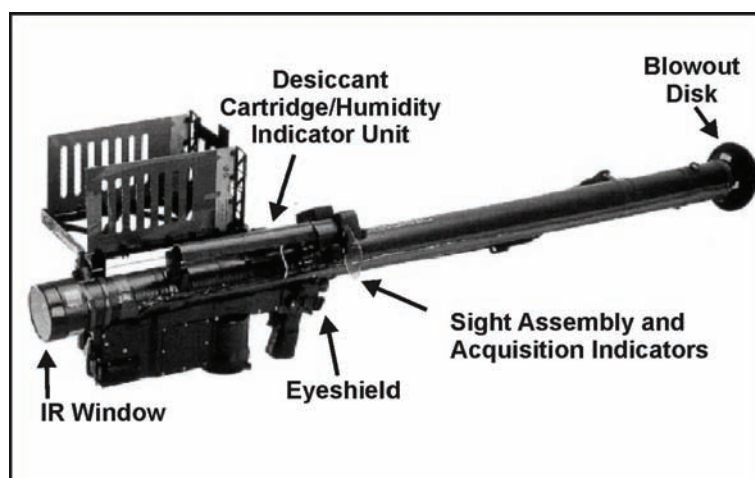
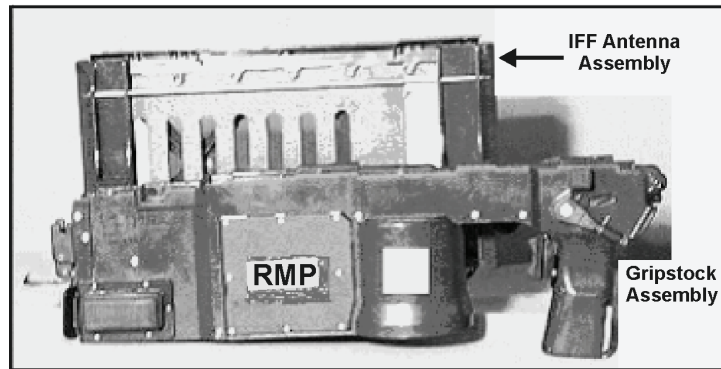

Figure 1-6. Stinger launch tube assembly

## GRIPSTOCK RMP/BLOCK1

1-24. The RMP and RMP/Block1 gripstock can be used with either version of the Stinger. They are shown in Figures 1-7 and 1-8, respectively.



**Figure 1-7. Stinger RMP gripstock**

1-25. The Stinger gripstock is attached to the launch tube by means of a latch mechanism located forward on the gripstock. Components that make up the gripstock are the IFF antenna assembly, IFF interrogate switch, safety and actuator device, firing trigger, uncaging switch, IFF interrogator connector, and BCU receptacle as shown in Figure 1-6. After missile launch, the BCU is removed immediately and the gripstock is removed from the launch tube for reuse. The tactical gripstock is readily identified by a yellow, 1-inch square located on the BCU receptacle. The gripstock can be reused until failure. Stinger is capable of interrogating and receiving coded replies. When not in use, the antenna assembly is folded and secured on the right side of the gripstock. Gripstocks without the RMP module installed can be used, but the missile will not have the enhanced performance capability. RMP-capable gripstocks contain the electronic housing that accommodates the RMP module, allowing for reprogramming of missile software to enhance performance in different threat environments.

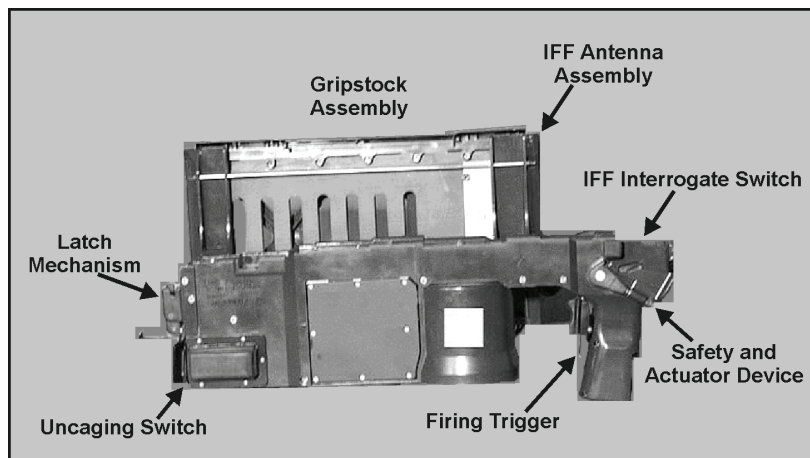

**Figure 1-8. Stinger RMP/Block1 gripstock**

## BATTERY COOLANT UNIT

1-26. The BCU is a thermal battery that generates extreme heat once activated. This thermal battery enables power to the missile electrical circuitry and argon coolant to the seeker during prelaunch operations. Due to this extreme heat, the BCU must be removed from the gripstock BCU receptacle immediately or within 3 minutes after missile launch to prevent damage to the gripstock. Due to excessive heat generated by the BCU, removing and handling the BCU must be done with caution to prevent burns to the hands. The BCU also houses pressurized argon gas to cool the IR/NUV detector prior to missile launch. The needle located atop the BCU through which argon gas travels to the seeker for cooling should be checked for damage and the rubber grommet should not be pushed down, exposing open end of needle. In Figure 1-9, the rubber grommet has been pushed down, exposing the open end of the needle. The contact rings (atop the BCU) are checked for corrosion and its housing checked for cracks. The tactical BCU is readily identified by one, 1-inch yellow square located on the body of the BCU.



**Figure 1-9. Stinger BCU top view**

1-27. Located on the base of each BCU is a heat-sensitive indicator (HSI) and the burst disk diaphragm. The HSI should be pink or white (serviceable) as shown in Figure 1-10 and not dark grey (unserviceable). The burst disk diaphragm should be silver. Should any one of the aforementioned items be found defective, the BCU should be returned to the ammunition supply point.

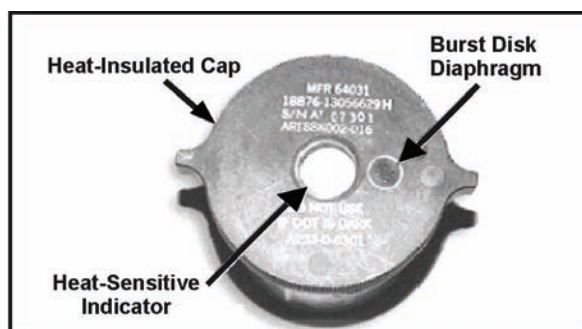
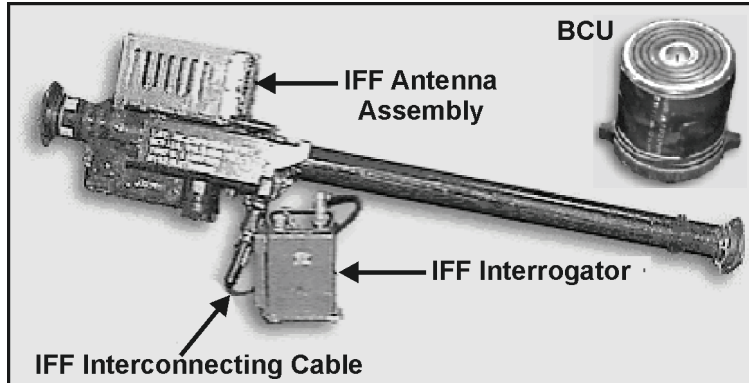

**Figure 1-10. Stinger BCU base**

## IFF ANTENNA AND INTERROGATOR SUBSYSTEM

1-28. The Stinger IFF interrogator subsystem is equipped with the AN/PPX-3 A or B (hereinafter referred to as the AN/PPX-3) IFF interrogator belt pack, IFF interconnecting cable, IFF antenna assembly, and a BCU to aid the gunner in identification of aircraft. See Figure 1-11. The basic visual differences between the two versions, A and B, is the addition of an electronic day indicator activating switch and a readout indicator located atop the interrogator on the B version. The interrogator is identified by a series of 1-inch yellow squares located horizontally around the mid-section of the unit. The IFF system classifies aircraft as either Mode 4 positive friend (half-second beep, pause, half-second beep) and is considered a “true friend”

reply; or, if not received, automatically switches to Mode 3 (a single, one and one-half-second beep) and is considered only a “possible friend” reply. It does not identify aircraft as hostile. Should the aircraft’s transponder return an incorrect reply or no reply, the audible response will be “unknown” (a string of beeps). If no tone is heard, the IFF system is either nonoperational or the interconnecting cable is not secured correctly to the gripstock.



**Figure 1-11. Stinger IFF antenna and interrogator subsystem**

1-29. When the aircraft is placed in the range ring, the gunner initiates the IFF sequencing by pressing the IFF INTERROGATE switch on the gripstock. Once the gunner issues a challenge, the AN/PPX-3 transmits a coded signal to the aircraft. The aircraft’s transponder then processes the signal and returns a coded reply. The reply is received by the Stinger IFF antenna and is routed through the interconnecting cable to the AN/PPX-3 for decoding. The AN/PPX-3 then converts the reply into an audible tone which is then rerouted via the cable to the gunner as a positive or possible friend tone through the speaker.

### **IFF INTERROGATOR SYSTEM SUPPORT EQUIPMENT**

1-30. Figure 1-12 shows the support equipment for the Stinger IFF interrogator system. The support equipment consists of the following:

- IFF interconnecting cable.
- AN/PPX-3A or B IFF interrogator.
- An AN/GSX-1 or AN/GSX-1A IFF programmer/battery charger.
- KOI-18/transmission security (TSEC) tape reader.
- KIR-1C/TSEC computer/power supply model ZAC A/1.
- W1 program cable, W2 power cable, W3 computer cable, and a W4 tape reader cable.
- IFF interconnecting cable.

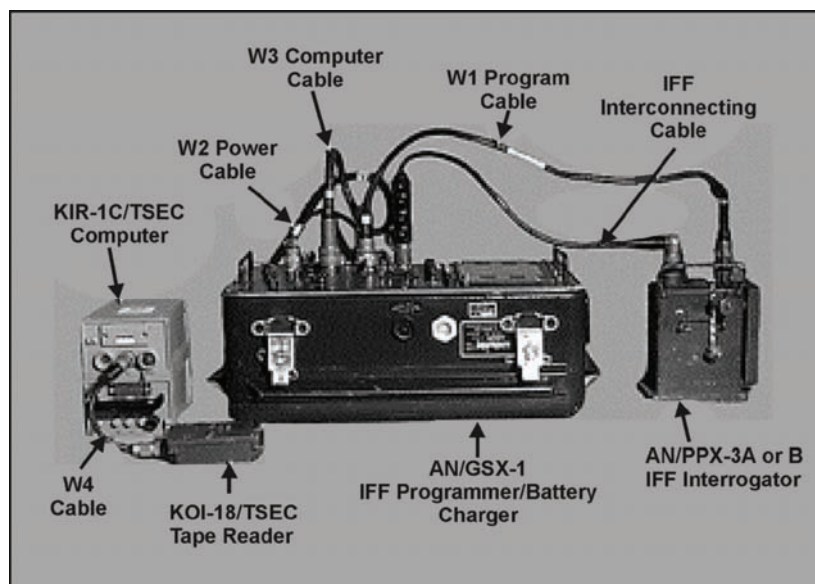

**Figure 1-12. Stinger IFF AN/GSX-1 interrogator system support equipment**

1-31. The KIR-1C/TSEC computer can only be loaded with 2 days of codes at one time from the KOI-18/TSEC tape reader and are classified as CONFIDENTIAL and must be safeguarded as outlined in TB 380-41. The evaluator module located within the interrogator is also classified CONFIDENTIAL, and proper security measures must be taken. The AN/GSX-1 programmer/battery charger is being modified to the 1A configuration to accommodate the AKAT 3662 “live-code” tape, the AKZT 3662 training tape for the tape reader, and the AN/CYZ-10 automated network control device (ANCD) shown in Figure 1-13.



**Figure 1-13. AN/GSX-1A, KIR-1C/TSEC, and KOI-18/TSEC**

### WEAPON-ROUND METAL SHIPPING AND STORAGE CONTAINER

1-32. The Stinger weapon-round metal shipping and storage container provides environmental protection for one complete weapon-round; three BCUs, one set of earplugs, and an attached gripstock. The weapon-round container (WRC) identification markings are yellow with two, 2 ½-inch squares located at each corner (top and bottom) of the container. The container is environmentally secured by four latches. A lifting and carrying handle at each end allows for the minimum two-man carry safety requirement. A push-and-release pressure relief valve is located on the lower latch side, forward end of the container to relieve internal container pressure prior to opening. A humidity indicator viewing port is located at the lower right, forward end of the WRC and indicates the percentage of moisture, if any, within the container. See Figure 1-14.

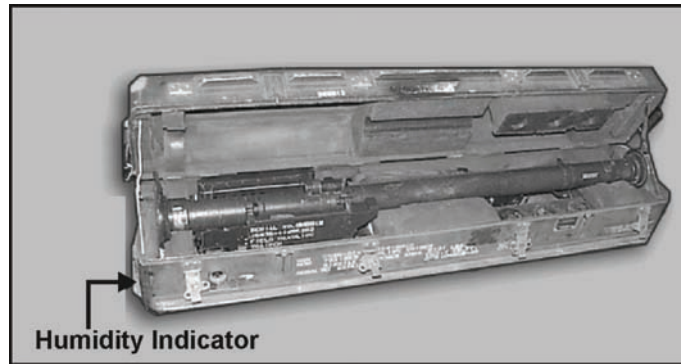

Figure 1-14. Stinger weapon-round metal shipping and storage container

### MISSILE-ROUND WOODEN SHIPPING AND STORAGE CONTAINER

1-33. The Stinger missile-round is shipped in a distinctive wooden missile-round container (MRC) shown in Figure 1-15. It can hold a missile-round, three BCUs, and one set of earplugs housed in a sealed barrier bag. The humidity indicator viewing port functions in the same manner as on the WRC. A gripstock with IFF antenna is not included.

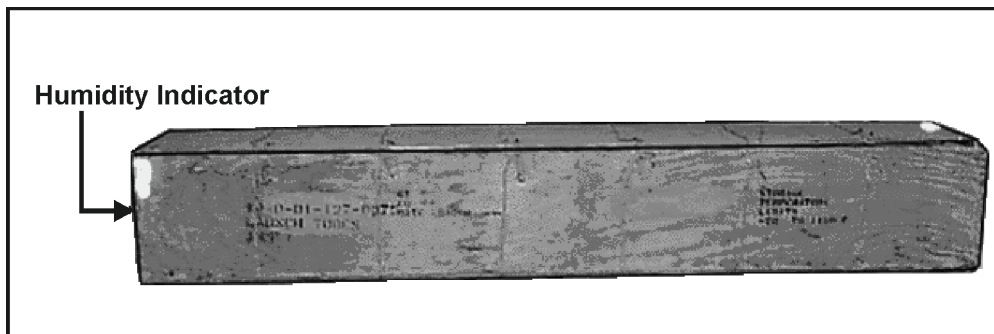

Figure 1-15. Stinger missile-round wooden shipping and storage container

### EMPLOYMENT CONSIDERATIONS

1-34. The areas listed below must be considered when employing the Stinger:

- Assigned sectors of fire established.
- Primary and alternate firing positions established.
- Missile backblast requires 45 meters (150 ft) of clearance behind the weapon.

- Personnel within 125 meters (400 feet) must wear hearing protection.
- No firing with the launch tube elevated more than 65 degrees or less than 10 degrees, or with the aft end of the launch tube closer than approximately 30 inches from the ground, to minimize the possibility of injury from flying debris.

### **STATIONARY POINT DEFENSE**

1-35. Stinger's ability to engage approaching aircraft makes it valuable for stationary point defenses. Its effectiveness is significantly enhanced when other ADA systems are allocated to the same defense. Teams should normally be positioned so that the engagement capability of one team overlaps that of an adjacent team. Positioning teams from 2 to 3 kilometers apart will provide this capability. In cases where more than one weapon system is employed in the same defense, overlapping fires should be achieved between weapon systems. When the tactical situation permits, teams must be positioned far enough out from the defended asset(s) to allow for early engagement (meaning the engagement of aircraft prior to ordnance release).

### **MOBILE POINT DEFENSE**

1-36. Stinger provides the ADA commander with an excellent capability to protect mobile assets to include moving maneuver units. MANPADS teams will often provide air defense for units moving in convoy or march column along roads behind the line of contact. Stinger defense of such convoys may be conducted by either pre-positioning teams along the route of march at key points, such as choke points and bridges, or integrating the teams into the march column. When integrated into the convoy, the positioning of the MANPADS teams will depend on convoy length and available MANPADS weapons.

1-37. Placing the team away from the defended asset is desired whenever possible for engagement and destruction of the target prior to its ordnance release line, providing gunners sufficient time to ready their weapons. When not alerted, teams will have their MANPADS configured weapons nearby even as they perform their own security and maintenance duties. System effectiveness largely depends upon gunner reaction time. The teams need to know the weapon control status in effect at all times to increase their effectiveness. Moreover, teams should be well trained on types of aircraft expected to operate within the theater of operation and those expected tactics these aircraft would use.

**This page intentionally left blank.**



## Chapter 2

# Patriot

This chapter describes the Patriot air defense weapon system and the roles Patriot plays in supporting the various types of AMD operations. Patriot provides critical AMD support to a variety of mission scenarios. It is critical in all situations that C<sup>2</sup>, coordination, identification of friendly and enemy assets, and protection of the forces are maintained. For this to occur, Patriot must maintain critical links with U.S. and allied members of the Joint Theater Forces through its communications assets.

### MISSION

2-1. The mission of Patriot is to protect forces and selected geopolitical assets from aerial attack, missile attack, and surveillance. Patriot provides protection against theater missiles (TMs) and air threats to critical assets in the corps and theater areas. TMs constitute the primary threat to be countered by Army ADA forces. Patriot can be tailored to the tactical situation in defending against air and missile attack.

### ROLE

2-2. The role of the Patriot system is to accomplish the air defense mission within the low-altitude to high-altitude boundaries because of its firepower, range, and altitude capabilities. Patriot is the lower-level tier of a two-tier TM terminal defense system.

2-3. Patriot units are employed to protect forces and critical assets in all types of operations. Patriot units may be deployed individually or as part of an ADA task force (ADATF) to protect entering forces, airfields, seaports, transportation centers, population centers, C<sup>2</sup>, communications system, and intelligence activities, and geopolitical assets. The ADATF may include THAAD, SHORAD weapon systems, and other joint and multinational units.

### THREAT DURING LODGMENT ENTRY OPERATIONS

2-4. Patriot helps to secure the lodgment in entry operations. As the theater develops and entering forces expand into corps areas, Patriot units support the shaping and decisive operations. Some Patriot units move with maneuver forces to provide protection for these forces and critical assets. Other Patriot units remain at theater of operations and continue to provide air and missile defense of critical assets.

2-5. Some Patriot units may remain in theater as a conflict is resolved. These units prevent residual enemy forces from successfully attacking geopolitical assets or friendly forces that are being redeployed.

2-6. Patriot may deploy during operational environment operations to contain localized conflicts, thus obviating the need for a major military response. In these conflicts, Patriot units can be employed to protect forces, civilian populations, and selected military and civilian assets from air, missile, and surveillance threats.

2-7. Patriot units may also be used to promote stability within a country or region. In some countries, terrorists or rogue elements may threaten to disrupt normal civil and political activities using

Contents	
Mission.....	2-1
Role .....	2-1
Threat During Lodgment Entry Operations .....	2-1
Physical Description of Major Items .....	2-2

air and missile threats. Patriot units may be deployed to protect civilians and geopolitical assets, thereby discouraging enemy factions and promoting stability.

## PHYSICAL DESCRIPTION OF MAJOR ITEMS

2-8. Patriot is a guided missile (GM) system designed to defeat the AMD threat, which may include tactical ballistic missiles (TBMs), air-to-surface missiles (ASMs), CMs, FW and RW aircraft, and UASs. The system normally fights as a battalion, which usually consists of five batteries or fire units operating under the control of a fire direction center. However, there are some battalions that are currently structured to have six batteries due to theater and type of mission.

2-9. Physical descriptions of the major end items are provided below. More detailed descriptions of these items, their components, and subsystems can be found in the system manuals listed in the References section of this manual.

### ELECTRIC POWER PLANT III

2-10. The electric power plant III (EPP III) is the prime power source for the engagement control station (ECS) and radar set (RS) and consists of two 150-kw generators mounted on a 10-ton heavy expanded mobility tactical truck (HEMTT). See Figure 2-1. The electric power unit (EPU) is the prime power source for the information and coordination central (ICC) and communications relay group (CRG). Each ICC and CRG has an EPU, which consists of a 30-kw generator mounted on a PU 789 M trailer as shown in Figure 2-4 on page 2-4.

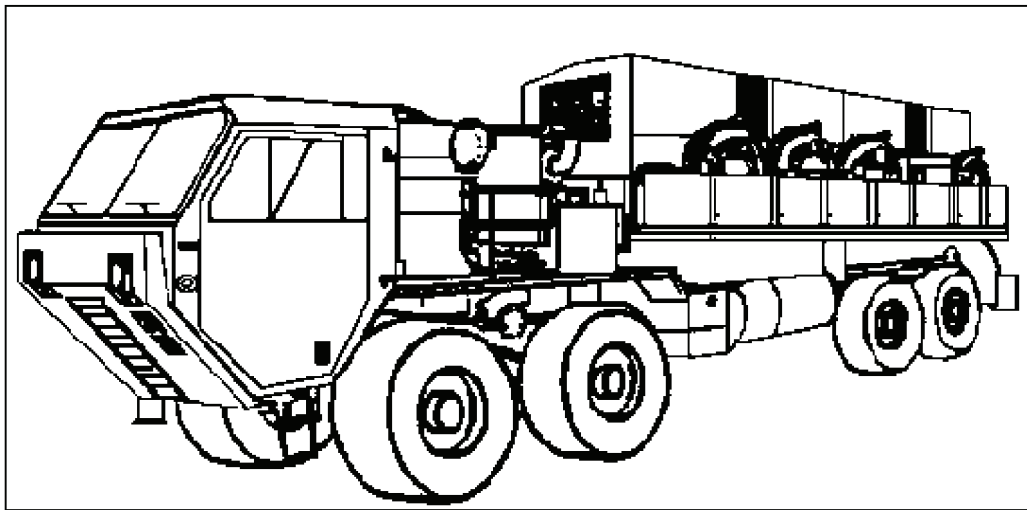

Figure 2-1. Electric power plant III

### INFORMATION AND COORDINATION CENTRAL

2-11. The ICC consists of a lightweight, weather-tight, shelter mounted on a 5-ton cargo truck (AN/MSQ-104) as shown in Figure 2-2. The shelter provides shielding from radio frequency interference (RFI) and electromagnetic pulse (EMP) radiation. It is equipped with two externally mounted air conditioners that cool, heat, and ventilate the interior. An externally mounted gas particulate filter unit (GPFU) is used in CBRN situations to provide clean air for crew members.

2-12. The ICC contains two consoles that are manned by the tactical director (TD) and tactical director assistant (TDA) to execute engagement operations. A communications work station is manned by a network switch operator. At least three crews of three personnel each must be available for continuous 24-

hour operations. Between the two consoles is an ICC status panel that displays the status of all battalion fire units.

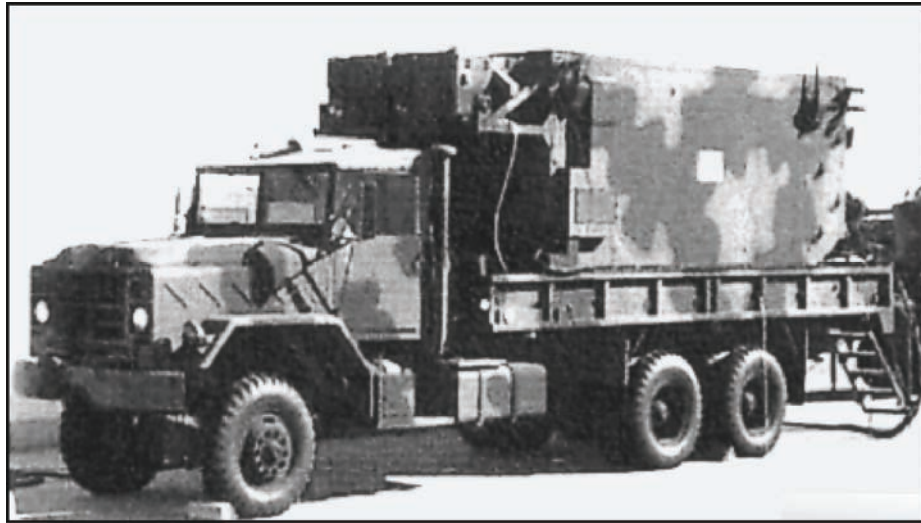

**Figure 2-2. Information and coordination central**

## **TACTICAL COMMAND SYSTEM**

2-13. The tactical command system (TCS), a 5-ton, truck-mounted, expandable shelter shown in Figure 2-3, is a highly mobile all-weather facility emplaced near the battalion ICC. It exchanges data with the ICC as well as provides voice communications. It provides the Patriot air defense battalion commander with state-of-the art equipment to implement and coordinate tactical planning and management activities. It is a facility which accommodates the commander and staff personnel with automated equipment to support force operation tasks that develop defense design planning. At least three crews with three personnel each must be available for continuous 24-hour operations.

2-14. The TCS has active software programs that help planners translate airspace control measures into Patriot initialization data for the battalion. The TCS consists of an air and missile defense workstation (AMDWS), a tactical planner workstation (TPW), common data link interface (CDLI), joint tactical terminal (JTT), and tactical satellite (TACSAT). It can display real time data based on operator selections. The TCS capabilities include, but are not limited to—

- Map display and control.
- Tactical overlays.
- Air situation.
- Deployment planning.
- Battle situation monitoring.
- Initialization data sent to the ICC.

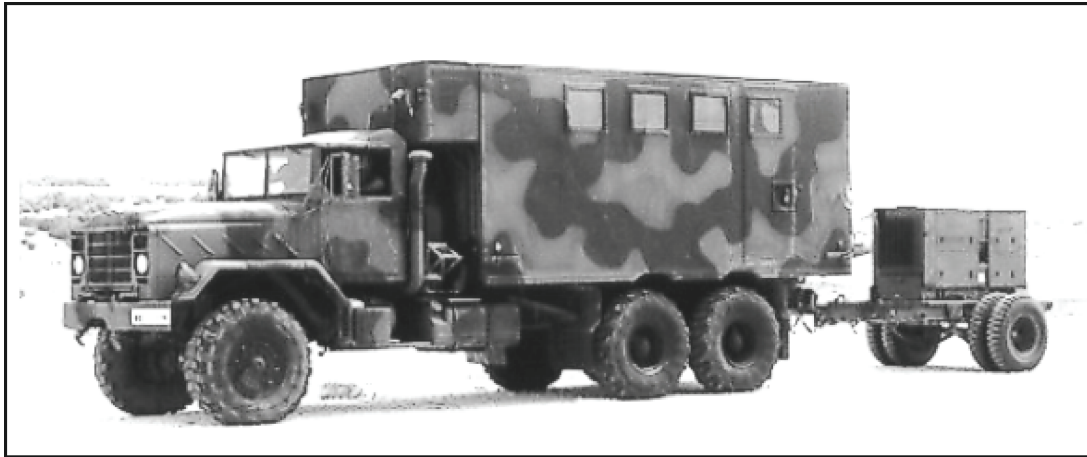

**Figure 2-3. Tactical command system with 15-kw generator**

### COMMUNICATIONS RELAY GROUP

2-15. The CRG consists of a weather-tight, CBRN-proof, shelter attached to a 5-ton cargo truck with a trailer-mounted EPU as shown in Figure 2-4. It is similar in appearance to the ECS. It provides a multirouted secure, two-way data relay capability, as well as voice communications between the ICC, its assigned fire units, and between adjacent units. The CRG can also operate as launch control station (LCS). This capability is critical for remote launch phase-3 operations. The CRG also provides the capability for both data and voice exit and entry communication points with elements that are external to Patriot. A 24-hour continuous operation is needed to meet mission requirements.

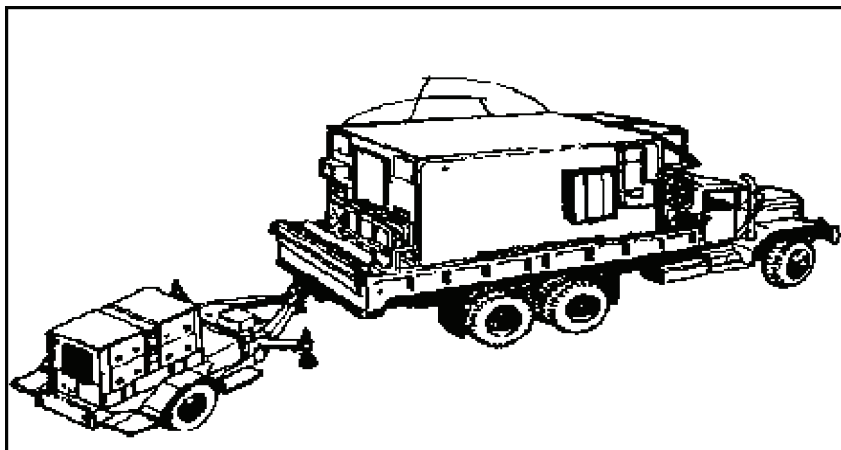

**Figure 2-4. Communications relay group with EPU**

### ENGAGEMENT CONTROL STATION

2-16. The ECS consists of a lightweight, weather-tight, shelter mounted on a 5-ton cargo truck (AN/MSQ-104) as shown in Figure 2-5. The shelter provides shielding from RFI and EMP, and, like the ICC, is equipped with two externally-mounted air conditioners and a GPFU. The left side, as seen from the doorway, includes three ultrahigh frequency (UHF) radio relay terminals, and a voice communications station. The right side includes the very high frequency (VHF) data link terminal (DLT), radar weapons control interface unit (RWCIU), weapons control computer (WCC), an AN/VRC-92A SINCGARS radio,

tactical storage device, and embedded data recorder. The ECS crew consists of a tactical control assistant (TCA), tactical control officer (TCO), and communications personnel. Three crews of three personnel each are responsible for running 24-hour continuous operations.



**Figure 2-5. Engagement control station**

## **BATTERY COMMAND POST**

2-17. Technology is now being integrated for the battery command post (BCP), Figure 2-6. The new Patriot BCP provides sheltered communications, computer and display facilities, as well as working space for the battery commander and staff. BCP equipment includes a HMMWV with a deployable rapid assembly shelter modular tent, which attaches to the back side of the vehicle.

2-18. Within the vehicle are an AMDWS station and a common hardware and software computer with an attached 8-mm tape drive and printer. The BCP runs off of a 10-kw generator. BCPs have dedicated elements to implement emergency survivability measures in case of chemical or ground attacks.

2-19. The BCP is operated by a crew of two AD C<sup>2</sup> communications system and intelligence tactical operations center (TOC) operators/maintainers. At least three crews must be available for continuous, 24-hour operations. The crew members are responsible for operating, maintaining, march ordering, and emplacing the BCP. Personnel required to support BCP operations must be capable of operating the AMDWS. Some of the BCP functions include—

- Tactical digital information link (TADIL)-J messages received and displayed on the BCP workstation.
- Situation awareness and early warning.
- Automated defense design and planning.
- AMDWS functionality/routing staff support.
- Integrated scenario development.
- AMDWS/tactical air planner capabilities to support defense planning and air battles.
- Intelligence received and processed.



**Figure 2-6. Battery command post**

### **RADAR SET**

2-20. The RS (Figure 2-7) consists of a multifunction, phased array radar mounted on an M-860 semitrailer towed by an M983, HEMTT. It is monitored and controlled by the ECS via the RWCIU. The RS performs very low- to very high-altitude surveillance, target detection, target classification, target identification, target track, missile track, missile guidance, and electronic counter-countermeasures (ECCM) functions.

2-21. The radar antenna is positioned at the forward end of the shelter and is erected to a fixed 67.5-degree angle relative to the horizontal plane during emplacement. Integral leveling equipment on the M-860 semitrailer permits emplacement on slopes of up to 10 degrees.



**Figure 2-7. Radar set**

## PAC-3 AN/MPQ-65 RADAR

2-22. The Patriot Advanced Capability-3 (PAC-3) AN/MPQ-65 radar, with new enhancements, provides significant improvements in expanded search, threat detection, and identification and engagement capability. In addition, the radar search sector volume has been expanded and a search-tailoring feature has been incorporated. PAC-3 radar enhancements provide for additional search sectors that improve search and track functions against TBM threats. The addition of the high-altitude cruise missile search sector enhances the system's ability to detect and counter air-launched cruise missiles.

## PAC-3 LAUNCHER

2-23. The launching station (LS) is mounted on an M-860 semitrailer towed by an M983 HEMTT (Figure 2-8). Leveling equipment permits LS emplacement on slopes of up to 10 degrees. The LS is trainable in azimuth  $\pm 110$  degrees and elevates to a fixed, elevated, launch position. The LS has to be precisely emplaced and aligned prior to launch. Proper emplacement and alignment are critical for engagement of any threat.

2-24. The current Patriot launcher has been modified to accommodate the new PAC-3 missile and serves as an interchangeable launcher platform. The upgraded launcher is referred to as a PAC-3 launcher and is capable of accommodating the PAC-3 missile or the current inventory of Patriot missiles.

2-25. Each PAC-3 launcher will include the enhanced launcher electronics system (ELES), a junction box (J-box) containing a launching station diagnostic unit (LSDU), and new interface and umbilical cables for the PAC-3 missile. The ELES performs the electrical interface functions between the PAC-3 launcher and the PAC-3 missiles to the ECS through the fiber-optics cable or SINCGARS VHF radio.

2-26. The ELES replaces the launcher electronics module (LEM) and occupies the same location on the launcher. The power distribution unit internal to the LEM was replaced with a peripheral control unit (internal to the ELES) for control of additional power supplies required by the PAC-3 missile functions. The J-box replaces the launcher/missile round distributor on PAC-3 launchers.

2-27. During operations, the ELES may be connected to 16 PAC-3 missiles or four PAC-2 missiles. The ELES is comprised of the launch control unit, motor control unit, power control unit, connector interface panel, and J-box. The J-box interfaces the ELES and missile canisters, either PAC-2 or PAC-3 missiles. There is no mixing of PAC-3 missiles or PAC-2 missiles on the same launcher.

2-28. The generator for the LS is located on the yoke assembly of the trailer and includes a built-in 56.8-liter (15-gallon) fuel tank. It has side-mounted work platforms. The unit is diesel engine-driven, 15-kw, four-wire, 400-hertz, with 120/208-volt power.



**Figure 2-8. Patriot PAC-2 or PAC-3 LS (emplaced)**

## ANTENNA MAST GROUP

2-29. The antenna mast group (AMG), as illustrated in Figure 2-9, is a mobile antenna mast system used to carry the amplifiers and antennas associated with the UHF communications equipment located in the ECS, ICC, and CRG. Four antennas are mounted in two pairs, are remotely controlled in azimuth, and can be elevated to heights up to 100 feet and 11 inches, above ground level.

2-30. Emplacement consists of stabilizing the AMG, setting the antenna feed and the erection of the antennas by the use of self-contained hydraulic and pneumatic systems and then adjusting the antenna azimuth. The emplacement slope for the AMG should not be more than 10 degrees for crossroll and ½ degree for roll. Connecting cables to the collocated shelter are carried on the AMG, which also includes radio frequency (RF) cables, control cables, and a prime power cable.

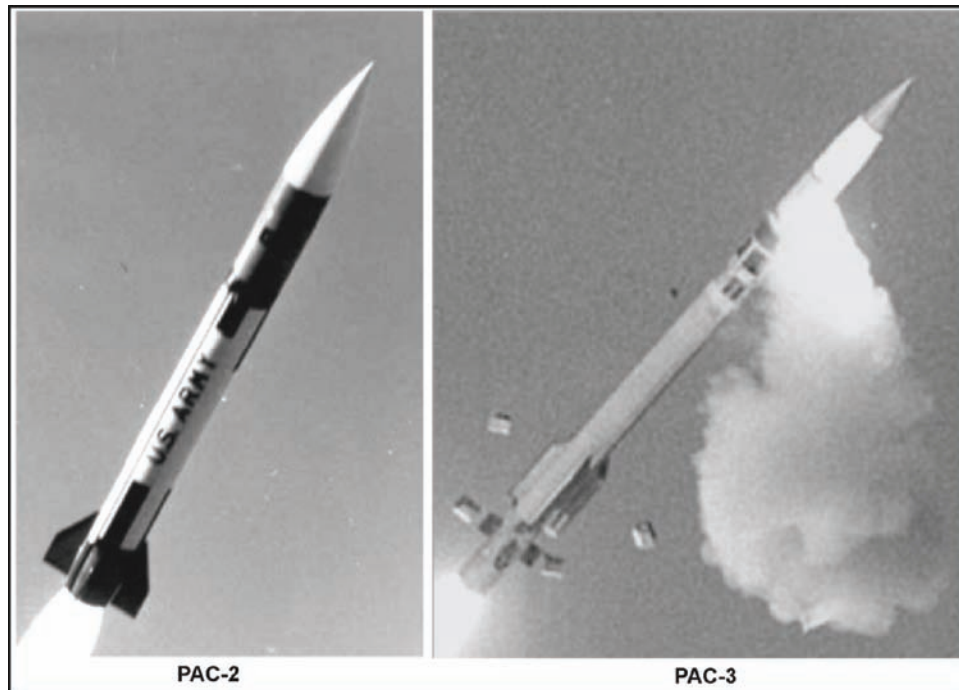

**Figure 2-9. Antenna mast group**

## PAC-3 MISSILE CHARACTERISTICS

2-31. The PAC-3 missile is considerably smaller than the other Patriot missiles, as viewed in Figure 2-10, allowing 16 to be loaded onto the launching station versus four of the others. Because the different versions have different capabilities and limitations, there are strict guidelines regarding their selection and use against different threats. (For more detailed information, refer to FM 3-01.85.)





**Figure 2-10. Patriot missiles**

2-32. The current Patriot missile inventory includes seven different missile types. These missiles come in a missile canister, packaged one missile per canister and shipped as a certified round. They are referred to as—

- **Standard** (MIM-104/MIM-104A). This was the first missile fielded with Patriot and contained an analog fuze. This fuze was replaced by a digital version with the fielding of the MIM-104A. Both missiles provide excellent performance against air-breathing threats (ABTs) and adequate performance against certain TBMs. The warhead fragment size limits performance against TBMs to a mission kill.
- **Standoff jammer counter** (SOJC). The SOJC missile (MIM-104B) is used to counter the long-range electronic countermeasures (ECM) threat. The guidance and navigation hardware was modified to allow the missile to fly a lofted trajectory to the jamming source and seek out the strongest emitter during the terminal phase. To achieve the lofted trajectory needed to maintain missile maneuverability at long range, missile acquisition is delayed for the SOJC mission. The SOJC missile retains the same performance against ABTs and TBMs as the standard missile.
- **ATM** (antitactical missile). The ATM missile (MIM-104C, PAC-2) is used to counter the advanced TBM threat. The missile has a new warhead and dual-mode fuze. The new dual-mode fuze allows the ATM missile to retain ABT performance and optimize TBM fuzing. The system software based on the specific mission selected for the missile sets the fuze mode.
- **ATM1**. The ATM1 missile (MIM-104D, guidance-enhanced missile [GEM]) provides improved capability over the ATM missile against TBMs and advanced ABTs. The ATM1 improves system effectiveness and lethality against high-speed TBMs and incorporates a footprint with and increased probability of kill. The ATM1 also has an increased lethality against advanced low radar cross-section (RCS) ABTs. There is an improved sensitivity in the track via missile (TVM) seeker, and an improved fuze reaction time.
- **ATM1T**. The ATM1T missile (MIM-104E, GEM+) provides a greater improvement over the ATM1 missile against high-speed TBMs, against the CM threat, and against low RCS, low-altitude ABT threats. The ATM1T has an improved low noise frequency generator that increases the sensitivity of the TVM seeker. This low noise frequency generator modification required

improvements to the fuze processor to provide an even greater sensitivity and earlier detection of targets.

- **ATM1C.** PDB-6 has added the capability of the new ATM1C missile (MIM-104F, GEM variant) along with the already fielded missiles. The new missile type is selectable for all target types and provides a greater improvement and greater lethality against CMs and against low RCS, and low-altitude ABT threats.
- **ATM2.** The ATM2 missile (PAC-3) provides the best performance against the high-speed TBM threat. The ATM2 missile incorporates into the missile its own on-board high resolution active seeker antenna, which communicates directly with the fire solution computer in the ECS through the RS. This has the advantage of the missile not using any assigned TVM tracking slots during the terminal phase of the engagement. The ATM2 missile is a hit-to-kill missile and has no warhead, but does employ a lethality enhancer that increases the odds of a first-shot kill. To provide it with the capability of hit-to-kill, it incorporates an aerodynamic/thrust-maneuvering system. The ATM2 missile is vastly different from the other missiles in that it is longer and not as wide, and is shipped with four missiles per canister.

2-33. There are no visible differences between the standard, SOJC, ATM, ATM1, ATM1T, and ATM1C.

2-34. The Patriot missile comes as a certified round, meaning that the missile requires no checkout prior to launch. The missile is shipped in a canister, which also serves as a launching tube.

### **BATTALION MAINTENANCE EQUIPMENT/BATTERY MAINTENANCE GROUP**

2-35. Patriot support equipment consists of standard Army vehicles that have been modified and equipped for use with the Patriot system. They function as the maintenance and supply centers required for Patriot tactical equipment at the battery and battalion headquarters levels. Patriot support equipment is shown in Figure 2-11. Repair parts, maintainer tools, test and handling equipment, publications, and maintenance and supply records are stored in the vehicles. These items are described below:

- The maintenance center (MC) is a semitrailer-mounted shop van that contains the tools, and test and handling equipment necessary to maintain the Patriot system. It is used at battery and battalion levels. The headquarters and headquarters battery (HHB) MC is configured to function as a small repair parts transporter (SRPT). The PU-732M, 15-kw, 400-hz, trailer-mounted, diesel generator set provides the power.
- The guided missile transporter (GMT) is a modified HEMTT M985 with a heavy-duty materiel-handling crane attached at the rear of the vehicle. It can be used for the delivery, recovery, and loading of guided missiles. It is on the HHB TOE. Location of the GMT (whether it remains at the battery or is retained at the battalion S-4 during combat or other operations) is determined by how missiles will be resupplied to the battalion.
- The large repair parts transporter (LRPT) is a HEMTT M977 cargo truck with a light duty material-handling crane. It is used to store and transport large, heavy repair parts.
- The SRPT provides a means to transport small repair parts and assemblies. It is also used as a maintenance van when needed.

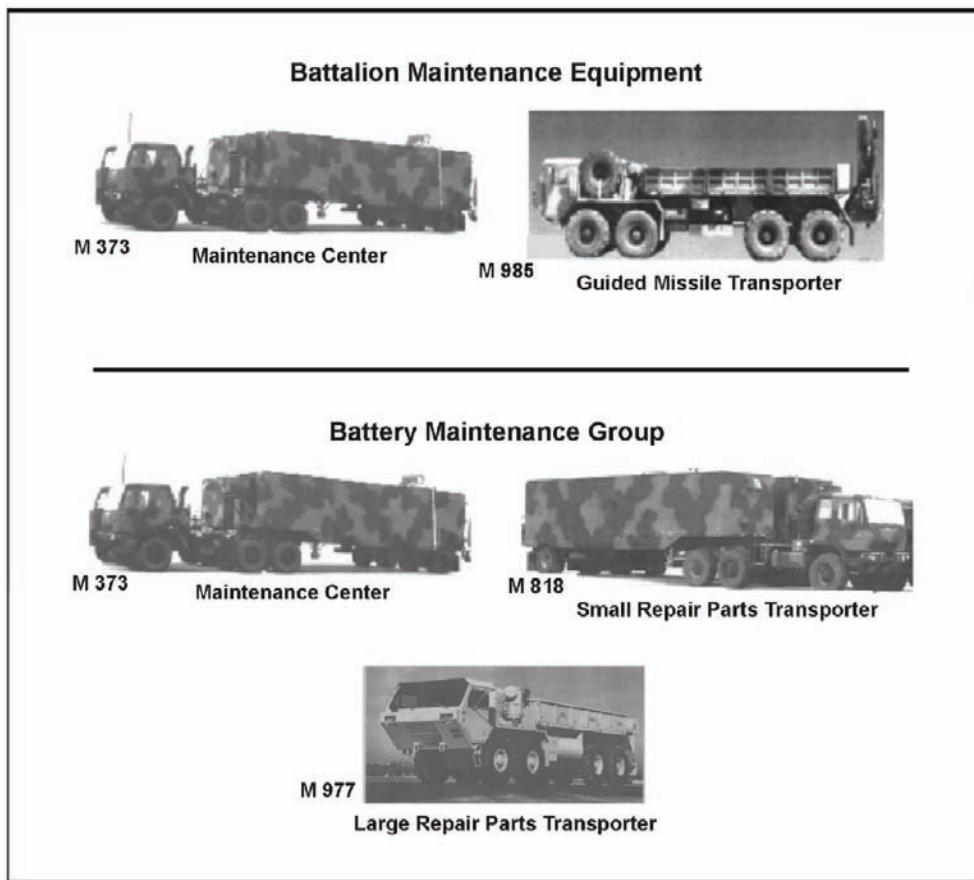

Figure 2-11. Patriot support equipment

**TACTICAL EQUIPMENT WEIGHTS AND DIMENSIONS**

2-36. Table 2-1 provides approximate weights and dimensions of tactical equipment in both customary and metric systems. This table also includes the weight of water and fuel.

**Table 2-1. Patriot tactical equipment weights and dimensions**

Equipment	Maximum Weight	Maximum Overall Dimensions		
		Height	Width	Length
RS with M983 prime mover (AN/MPQ-65)	78,030 lb 35,485 kg	11.83 ft 3.61 m	9.52 ft 2.90 m	55.77 ft 17.00 m
ECS, mounted, (AN/MSQ-104) with M927, 5-ton tractor truck without winch	37,780 lb 17,137 kg	11.92 ft 3.63 m	8.95 ft 2.73 m	32.10 ft 9.78 m
EPP III mounted on M977 tractor with winch	59,910 lb 27,174 kg	11.25 ft 3.43 m	8.5 ft 2.59 m	33.4 ft 10.18 m
AMG, OE-MRC, with M942, 5-ton tractor with winch	37,170 lb 16,860 kg	1.75 ft 3.58 m	8.26 ft 2.52 m	35.13 ft 10.71 m
LS, GM with 15-kw generator, with M983 tractor and trailer, no missiles	67,010 lb 30,395 kg	11.50 ft 3.50 m	9.42 ft 2.87 m	55.96 ft 17.06 m

Table 2-1. Patriot tactical equipment weights and dimensions (continued)

<i>Equipment</i>	<i>Maximum Weight</i>	<i>Maximum Overall Dimensions</i>		
		<i>Height</i>	<i>Width</i>	<i>Length</i>
LS, GM, with 15-kw generator with M983 tractor and trailer with four GMs (PAC-2)	82,010 lb 37,199 kg	13.08 ft 3.99 m	9.42 ft 2.87 m	55.96 ft 17.06 m
Four GMs (PAC-2) with canisters, no truck, no trailer	15,000 lb 6,804 kg	6.50 ft 1.98 m	7.04 ft 2.15 m	20.0 ft 6.10 m
PAC-3 launcher trailer set, without prime mover, with 15-kw generator, no missiles	35,000 lb 15,876 kg	11.50 ft 3.50 m	9.42 ft 2.87 m	33.66 ft 10.26 m
Four GMs (PAC-3) with canister, 16 missiles total, no truck, no trailer	18,552 lb 8,415 kg	6.50 ft 1.98 m	7.04 ft 2.15 m	20.0 ft 6.10 m
PAC-3 LS, without prime mover, with 15-kw generator, with four GMs (PAC-3) with canister, 16 missiles total	53,552 lb 24,291 kg	13.08 ft 3.99 m	9.42 ft 2.87 m	33.66 ft 10.26 m
EPU II PU 804, trailer-mounted, no tractor, full with fuel	5,920 lb 2,685 kg	7.00 ft 2.13 m	7.92 ft 2.41 m	13.75 ft 4.19 m
MC with M932 tractor	40,680 lb 18,452 kg	11.42 ft 3.48 m	8.17 ft 2.49 m	46.07 ft 14.04 m
SRPT with 5-ton M932 tractor	39,390 lb 17,867 kg	11.42 ft 3.48 m	8.17 ft 2.49 m	46.07 ft 14.04 m
LRPT with light duty materiel handling equipment crane, with M977 tractor with winch assembly (prescribed load list parts not included)	40,241 lb 18,253 kg	11.92 ft 3.63 m	8.44 ft 2.57 m	33.42 ft 10.19 m
GMT truck with heavy duty crane, no missiles, M985E1 tractor and trailer with winch	41,090 lb 18,638 kg	6.08 ft 1.85 m	8.44 ft 2.57 m	35.73 ft 10.89 m
ICC, AN/MSQ-16, with M928 5-ton, tractor without winch assembly.	37,000 lb 16,783 kg	11.99 ft 3.66 m	8.54 ft 2.60 m	32.08 ft 9.78 m
CRG, AN/MRC-137, with M927 5-ton, tractor without winch assembly	34,690 lb 15,735 kg	11.99 ft 3.66 m	8.54 ft 2.60 m	32.08 ft 9.78 m
TSC, AN/MSQ 129, with M934A1 tractor	29,280 lb 13,309 kg	11.86 ft 3.61 m	8.17 ft 2.49 m	30.22 ft 9.21 m
HEMTT, 10-ton, M983	32,880 lb 14,914 kg	9.25 ft 2.82 m	8.46 ft 2.58 m	29.29 ft 8.93 m

Table 2-1. Patriot tactical equipment weights and dimensions (continued)

<i>Equipment</i>	<i>Maximum Weight</i>	<i>Maximum Overall Dimensions</i>		
		<i>Height</i>	<i>Width</i>	<i>Length</i>
HEMTT, 10-ton, M983, fuel-empty- 2,500 gal	38,165 lb 17,311 kg	9.25 ft 2.82 m	8.46 ft 2.58 m	33.4 ft 10.18 m
HEMTT, 10-ton, M984A1 wrecker	50,900 lb 23,088 kg	9.25 ft 2.82 m	8.46 ft 2.58 m	32.7 ft 9.97 m
EPP III vehicle-mounted on M977 tractor with winch	52,910 lb 24,000 kg	11.25 ft 3.43 m	8.5 ft 2.59 m	33.40 ft 10.18 m
JP-8 fuel (1 gal)	6.7 lb 3.04 kg			
water (1 gal)	8.0 lb 3.63 kg			

**This page intentionally left blank.**

## Chapter 3

# Terminal High-Altitude Area Defense

This chapter describes the THAAD system, its mission and components. The THAAD system is a unique ballistic missile defense (BMD) system with both endoatmospheric and exoatmospheric intercept capability with high probability of kill.

### MISSION

3-1. The mission of the THAAD battery is to protect the homeland, deployed military forces, friends, and allies from short-range ballistic missiles (SRBMs) and medium-range ballistic missiles (MRBMs). In the future, THAAD may develop a capability against intermediate-range ballistic missiles (IRBMs). THAAD is a ground-based, deployable terminal missile defense system being fielded. As an element of the ballistic missile defense system (BMDS) terminal defense segment, THAAD will provide the opportunity to conduct endoatmospheric and exoatmospheric engagements against BMs that were not destroyed earlier in boost or midcourse phases of flight by other BMDS elements.

3-2. In the BMDS, THAAD is part of a terminal phase segment and is the upper tier defense of a multilayer defense system. While a single level, or tier, defense can provide a robust degree of protection for defended assets, a two-tier defense is required to provide a near-leak-proof defense at greater altitudes and ranges for defense of most critical assets. THAAD provides defense against threats directed against critical military assets and geopolitical assets. THAAD engages at high altitudes and long ranges to minimize collateral damage caused by CBRN warheads and debris.

### GENERAL TRAJECTORY PHASES

3-3. The THAAD system is part of a layered BMD architecture designed to give the U.S., our allies, friends, and deployed forces multilayer protection against any type of BM. Figure 3-1 shows the three general trajectory phases—boost, midcourse, and terminal.

<b>Contents</b>	
Mission.....	3-1
General Trajectory Phases .....	3-1
Battery Components .....	3-3

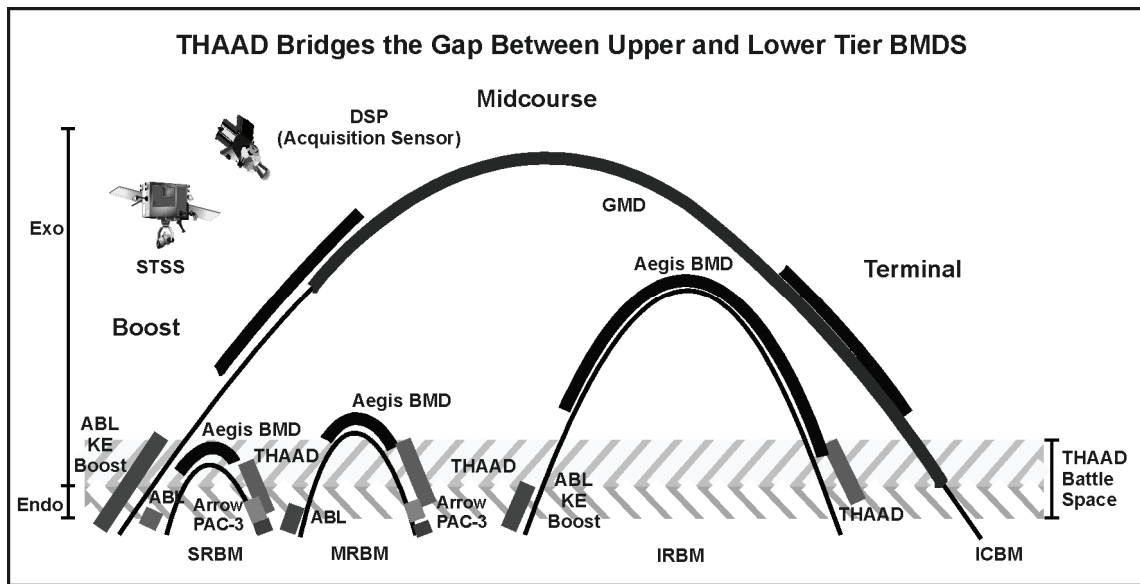

**Figure 3-1. General trajectory phase segments**

3-4. The boost phase of the BM trajectory is that segment of a BM's flight that lasts from launch through the completion of propulsion fuel burns. Typically, the entire boost phase occurs within the first 60 to 300 seconds of flight. Our sensors must detect a launch and relay accurate information about the missile very quickly. Interceptors must be positioned close to the launch point, or must be extremely fast to catch up to the accelerating missile. To engage ballistic missiles in this phase, real time launch detection, quick-reaction times, high confidence decision making, and multiple engagement capabilities are needed.

3-5. The midcourse defense segment is initiated once an incoming missile's booster stages are expended. The missile continues its ascent into the midcourse phase of flight, which allows the longest window of opportunity to intercept the incoming missile. At this point, the incoming missile has stopped thrusting and follows a more predictable path. Since the interceptor has a longer time to engage, fewer interceptor sites are needed to defend larger areas. A longer period in space provides an incoming missile the opportunity to deploy countermeasures against a defensive system, but the defensive system also has more time to observe and discriminate countermeasures from the incoming missile. The primary midcourse defense segments are ground-based midcourse defense (GMD) and Aegis BMD. The Aegis BMD system is intended to intercept hostile incoming missiles in the ascent, as well as descent, phases of midcourse flight. Complemented by GMD, this provides for an enhanced midcourse defense layer.

3-6. The terminal phase defense segment initiates when a threat missile or warhead begins to fall back into the atmosphere. The terminal phase of the BM's flight is usually only a few minutes. Defensive systems must be near the missile's target to defend against the attack. Countermeasures are less of a challenge in this phase. They usually fall slower than the warhead, or are burned up as they re-enter the atmosphere. Defensive systems designed for the terminal phase are most effective in protecting point targets, for example, troop concentrations, ports, airfields, and staging areas. The primary elements considered for the terminal defense segment are THAAD and lower-tier systems as shown in Figure 3-2.



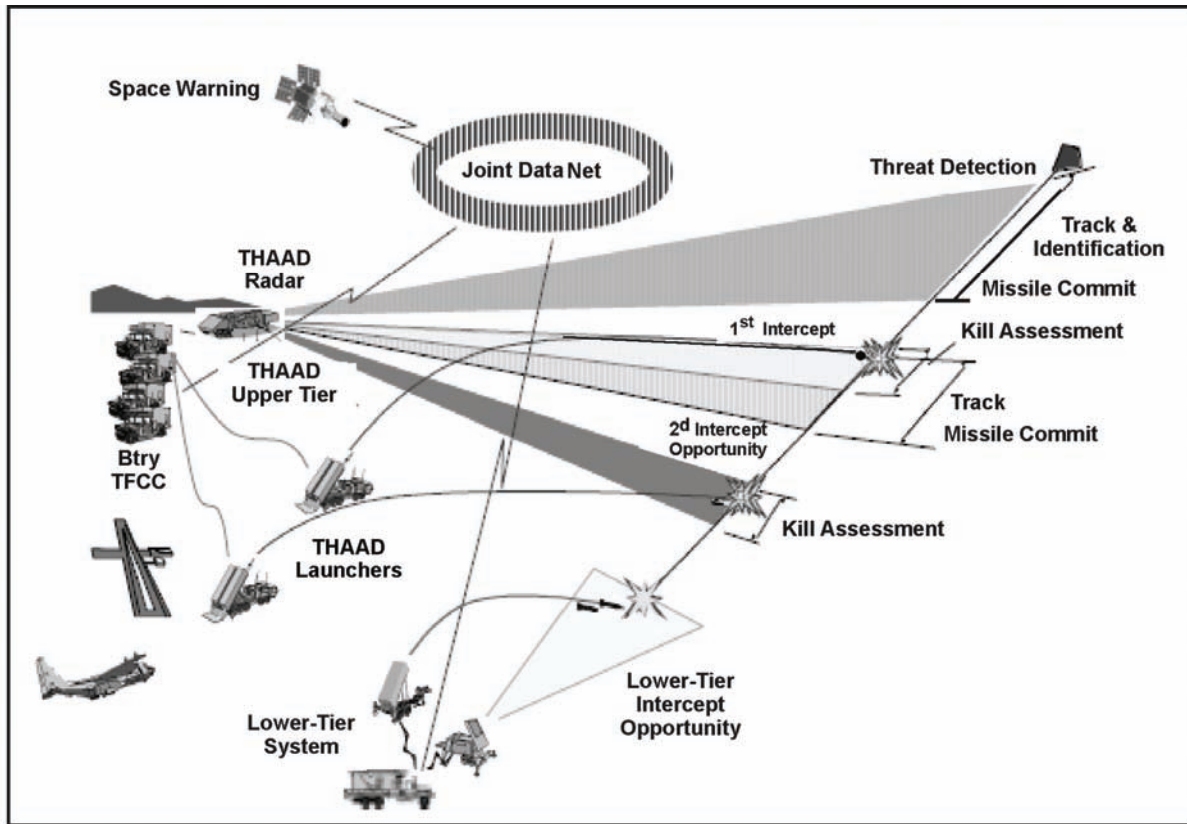

**Figure 3-2. Terminal phase defense segment**

3-7. THAAD defense against incoming BMs as part of the two-tier response is designed to provide a layered protection for critical, high-priority military and civilian geopolitical assets. THAAD contributes to the layered defense against BMs by providing the upper tier portion of the Army's two-tier defense. The THAAD mission is to protect multiple, widely dispersed assets from SRBMs and MRBMs. The Joint Theater Missile Defense operational concept recommends that THAAD be task-organized with lower-tier systems to form an ADATF, which is capable of providing a coordinated defense during all phases of maneuver and combat operations. Integration into an ADATF enhances THAAD survivability against air, cruise, and air-to-surface missile attacks. THAAD's broad area coverage capabilities enable ADA commanders the flexibility to support strategic maneuver.

3-8. THAAD is deployable worldwide, providing antiballistic missile capability for any theater of operations. The THAAD fire unit's defended footprint allows a single fire unit to defend a large number of assets. THAAD missiles destroy incoming threat warheads with lethal impact (hit-to-kill) at long ranges and high altitudes.

## BATTERY COMPONENTS

3-9. The THAAD battery consists of five components—the THAAD fire control and communications (TFCC), launcher, missile-round, radar, and peculiar support equipment.

### FIRE CONTROL AND COMMUNICATIONS

3-10. The role of the TFCC is to provide capabilities to conduct THAAD FU operations. The TFCC integrates the launcher and the radar and provides the planning, control, coordination, execution, and communications necessary to fulfill the THAAD mission in a coherent and fully integrated fashion. In

addition, the TFCC is interoperable with external AMD and intelligence systems and agencies and will be integrated into the Army ADA system of systems and the BMDS. The TFCC's functions involve planning the missile defense battle force operations (FO) and those activities associated with the actual conduct of the missile defense battle engagement operations (EO). The TFCC is composed of the tactical operations station (TOS), the LCS, and the station support group as shown in Figure 3-3. These three components together are called the tactical station group (TSG.) A THAAD FU includes two TSGs. The dual TSG configuration is standard with one TSG performing EO and the other performing other FO functions. The TSG can be rapidly reconfigured for EO and/or FO, in the event of equipment failure or malfunction, or to continue operations during relocation. A single TSG is capable of performing both EO and FO functions. Two TSGs make the TFCC. The TFCC is capable of site centered operations; that is, it can control collocated radar and launchers.

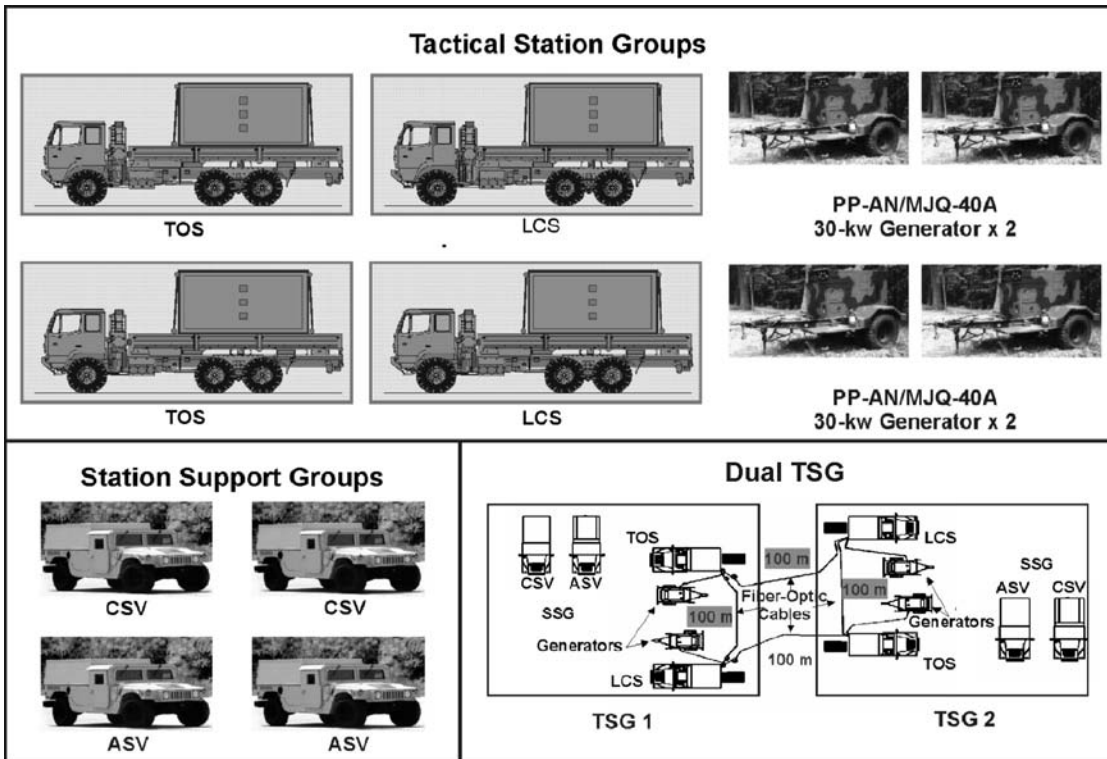

Figure 3-3. THAAD fire control and communications

**LAUNCHER**

3-11. The launcher is a mobile tactical element of the THAAD fire unit and is used to transport, aim, and launch THAAD missiles. The launcher is comprised of the transporter and the missile-round pallet (MRP) as shown in Figure 3-4.

**Transporter**

3-12. The THAAD transporter provides the principal means of missile transportation and serves as a stabilized missile launch platform. The transporter is based upon the U.S. Army M1120 HEMTT load handling system (LHS) variant. Modifications made to the M1120 to accommodate the THAAD MRP include a launch stabilization system, electrical interfaces, and a THAAD unique carrier electronics module (CEM). The CEM is the control center for the launcher. It monitors and reports real time launcher and missile status to the THAAD fire control over a fiber optic link (FOL). Other features include a dynamic

power architecture comprised of an on-board 3-kw generator/commercial input power source, and an on-board uninterruptible power supply.

### Missile-Round Pallet

3-13. The MRP is a modular platform designed to support and secure the THAAD missile-round canisters. The MRP provides physical connectivity and mating for the missile-round canisters during storage, transport, and tactical operations. The MRP incorporates an automated azimuth determination unit to provide the orientation relative to the launcher's local coordinates.

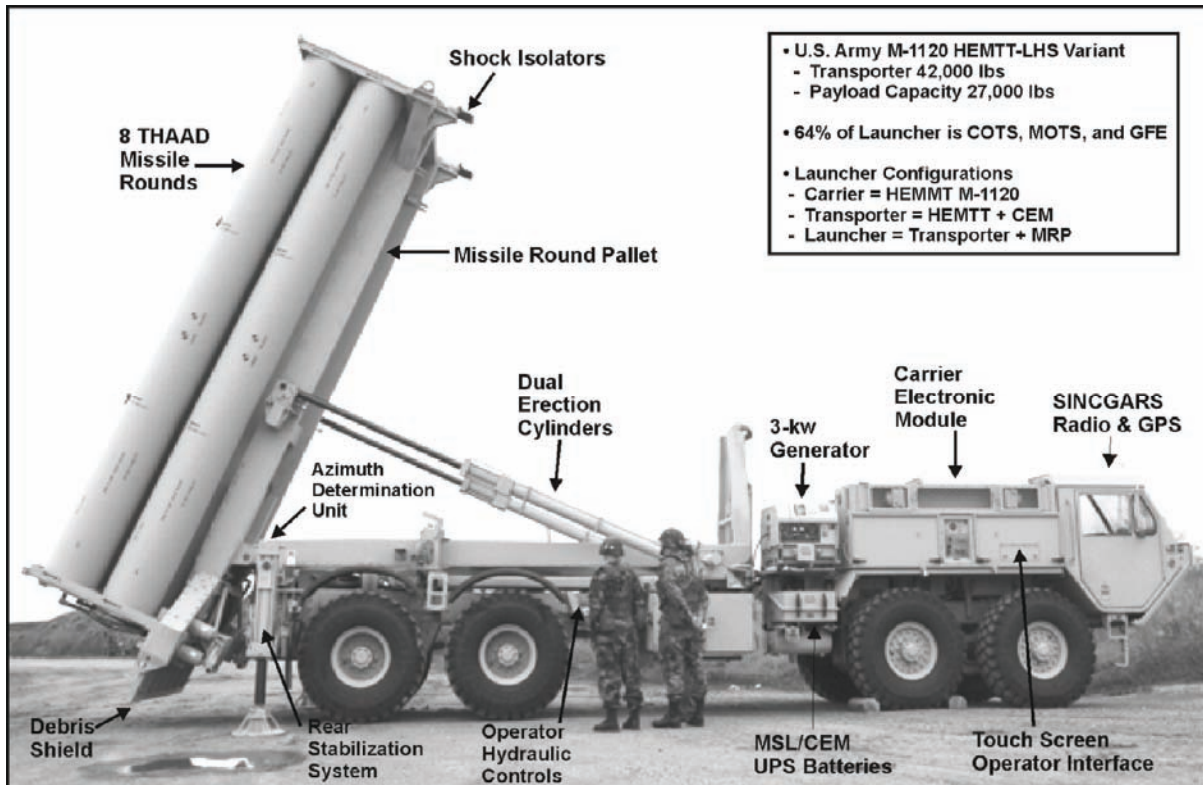
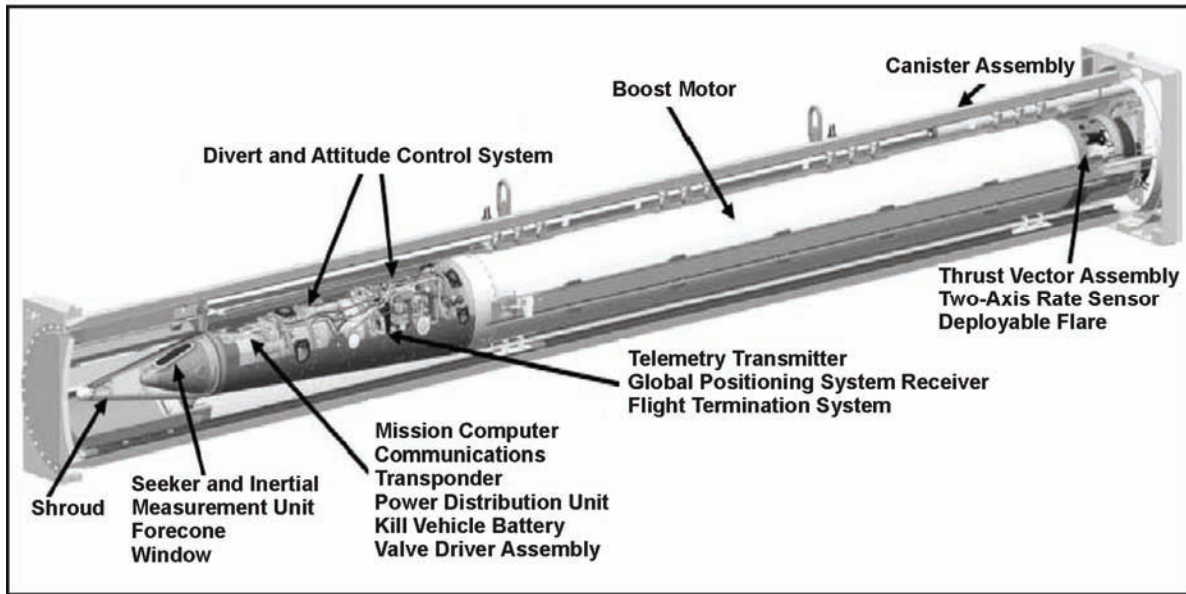

Figure 3-4. THAAD transporter and missile-round pallet

### MISSILE-ROUND

3-14. All THAAD missile-rounds are certified. Each certified round is stored in a strong, lightweight canister and consists of a single-stage booster and a kill vehicle with homing hit-to-kill capability. The canister serves as a nonreusable housing and launch tube providing environmental protection for the missile. The missile rocket motor provides all of the boost impulse for the missile. The missile uses an active thrust vector actuation system, two-axis rate sensor, and a deployable flare located at the aft end of the booster to provide stability and controllability during powered flight. The kill vehicle provides for high aim point accuracy intercepts and destroys its target through the transfer of lethal energy upon impact. The kill vehicle consists of an infrared seeker, an inertial measurement unit, a mission computer, avionics flight software, a divert and attitude control system, and a communications system. The missile, when integrated with the canister, makes up the missile-round as shown in Figure 3-5.



**Figure 3-5. Block 08 configuration missile-round**

## **RADAR**

3-15. The THAAD radar is an X-Band, solid state, phased array radar capable of tracking multiple threats and multiple interceptors during engagements. The THAAD radar uses fence, volume, and cued search modes, and provides surveillance, acquisition, track, discrimination, missile communications, and hit assessment for the THAAD fire control.

### **Radar Components**

3-16. The THAAD system radar components are transportable. The components consist of the antenna equipment unit (AEU), electronic equipment unit (EEU), cooling equipment unit (CEU), and the prime power unit (PPU) as shown in Figure 3-6.

#### *Antenna Equipment Unit*

3-17. The AEU transmits and receives radio frequency energy to support search, track, and the THAAD interceptor uplink/downlink messaging. The AEU is capable of transmitting multiple radio frequency beams sequentially and receiving beams simultaneously.

#### *Electronic Equipment Unit*

3-18. The EEU is an environmentally controlled shelter housing the electronic equipment used to generate the timing and control signals required of radar operation and signal processing. Two maintenance terminals, referred to as the control and display workstations, are located in a separate maintainers' area within the EEU. The radar interface to the fire control provides both digital and voice communications, and the interface to the missile provides in-flight digital communications. Within the THAAD radar, an inter-shelter communications system provides nonsecure voice communications between the maintainer/operators in the EEU and those working at the other shelters.

**Cooling Equipment Unit**

3-19. The CEU is a fully integrated, transportable trailer system, providing complete system cooling and power distribution for the THAAD radar system. The CEU transforms and provides power distribution from the commercial power source or the PPU to the AEU and EEU.

**Prime Power Unit**

3-20. The PPU is a self-contained transportable engine/alternator system. The primary function of the PPU is to produce electrical power required to operate the THAAD radar component. The PPU diesel engine produces power that is transmitted to the cooling equipment unit for distribution to the remaining radar assemblies.

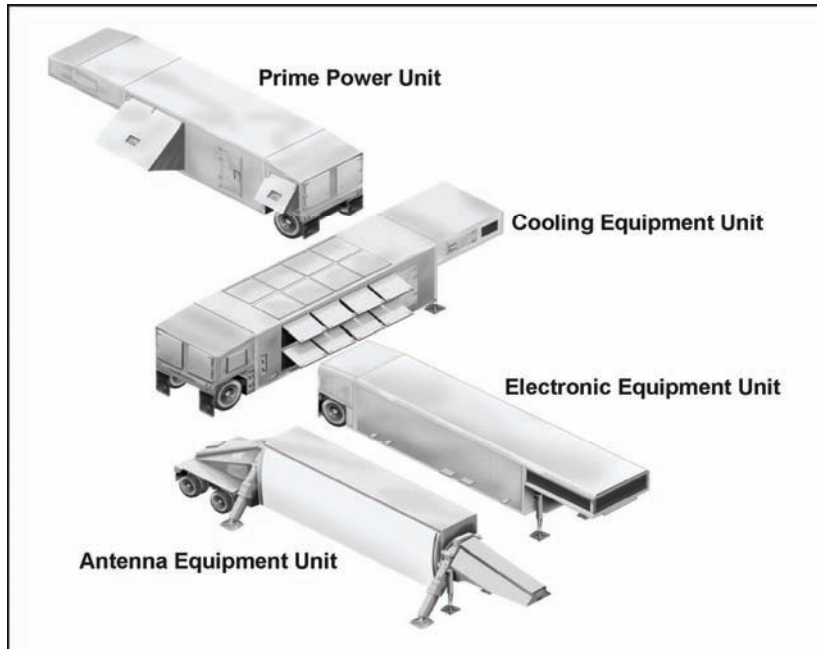

**Figure 3-6. THAAD radar components**

**PECULIAR SUPPORT EQUIPMENT**

3-21. The THAAD peculiar support equipment (PSE) component provides the resources to perform THAAD unique sustainment maintenance support functions at unit and depot-forward levels. The PSE hardware consists of a battery support center (BSC) and an interim contractor support system (ICSS). PSE and common support equipment items include—

- Prime movers.
- Generators.
- Radio sets.
- Test measurement and diagnostic equipment.
- Mechanical and electrical support equipment.

**Battery Support Center**

3-22. The BSC provides a mobile maintenance capability to the THAAD fire units to support remote maintenance monitoring, telemaintenance, spares management, and mobile support assistance. It consists of a battery logistics operation center, spares transport trailer, two mobile support trucks, and a deployable rapid assembly shelter. See Figure 3-7 on the next page.

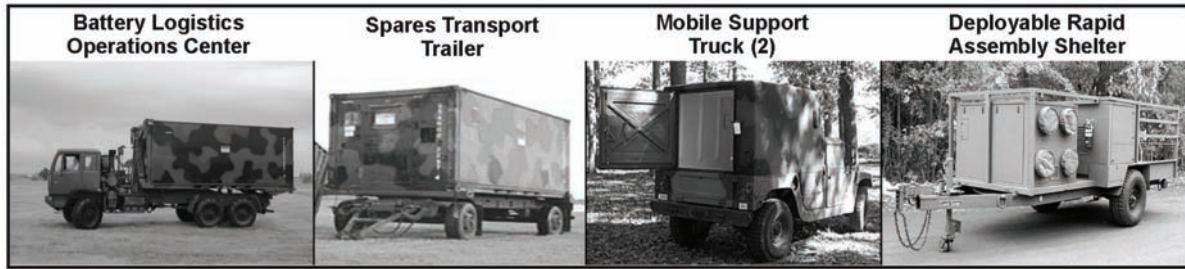

Figure 3-7. THAAD battery support center

**Interim Contractor Support System**

3-23. The ICSS shown in Figure 3-8 is designed to support contractor technicians deployed to the theater of operations as a depot-forward support cell. The ICSS is a modular support package capable of being responsive to the changing logistical needs of the deployed force. Depending upon mission needs, the ICSS can easily integrate into an intermediate support base and push forward support as needed through a larger distribution-based logistics system or rapidly move directly into theater and begin immediate sustainment operations under even the most spartan conditions. It provides in-theater storage and distribution of spare and repair parts, tools, test equipment, satellite communications capability for telemaintenance, video teleconferencing, radar file transfer via the data reduction network, Nonsecure Internet Protocol Router Network/Secret Internet Protocol Router Network connectivity, and remote supply and support functionality. It consists of a spares/communications transport shelter as well as a mobile support center and contact maintenance vehicles. The ICSS is not part of a modified table of organization and equipment. It will not be issued to the Government.

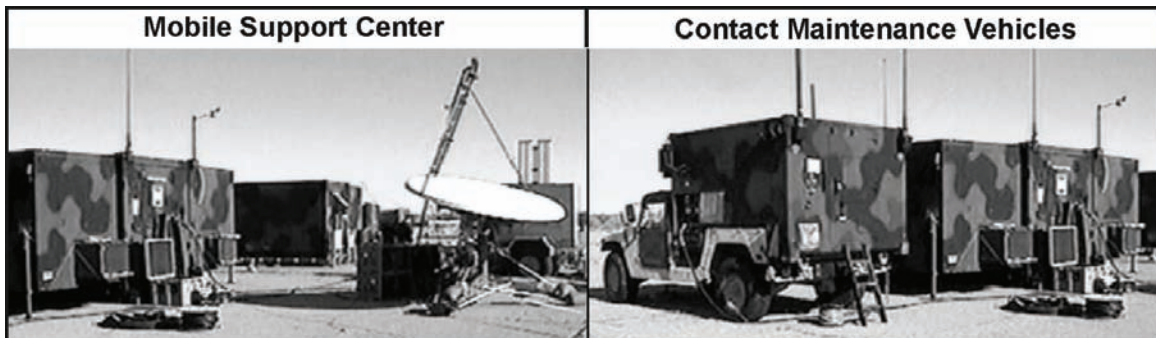

Figure 3-8. Interim contractor support system

## Chapter 4

# ADA Composite Battalion

This chapter discusses the ADA composite battalion and how it contributes to theater counter air operations. Missile defense protects the force and critical assets from attack by theater missiles, which include BMs, CMs, air-to-surface missiles, and large caliber rockets. This chapter discusses the organization of the ADA composite battalion, ADA planning overview, ADATF operations, and the ADA fire control officer (ADAFCO) in his role in the ADA composite battalion.

### MISSION

4-1. The mission of the ADA composite battalion is to provide critical air and missile defense coverage and timely early warning to multiple defended assets and maneuver units across the battlefield to allow freedom of maneuver and operations in a JIM environment.

### STRUCTURE

4-2. ADA brigades are assigned to divisions and corps to protect against theater missile attacks. Patriot batteries are task-organized with Avenger units, forming an ADA composite battalion. ADA battalions are deployed as modular, scalable, mission-tailored task forces that may consist of platoon, battery, or battalion-sized elements. Plans are developed with contingencies for different sized and configured ADA task forces, as dictated by mission requirements. As combat theaters mature, additional modules of TF elements may be added to meet changing mission, enemy, terrain and weather, troops and support available, time available, civil considerations (METT-TC) requirements and to tailor the TF to the employment principles of mass, mix, mobility, and integration. The ADA composite battalion is organized to meet Army Command, Army Service Component Command, and Direct Reporting Unit or brigade/brigade combat team (BCT) commander directives to accomplish the mission. The ADA composite battalion will organize according to METT-TC factors, the commander's intent, and the situation.

4-3. The ADA composite battalion currently consists of four Patriot firing batteries, one Avenger firing battery, one HHB and one organic maintenance company. One Patriot firing battery consists of six LSs, one RS, and one ECS. The ADA composite battalion has six Sentinel radars (two in HHB and four in the Avenger battery), and 24 Avenger fire units in the Avenger firing battery comprising three platoons. The firing batteries are controlled by the fire coordination center (FCC) to provide an effective and versatile combination of system capabilities with 360-degree coverage for a seamless air and missile defense while enhancing force protection capabilities. Organic to the battalion is a maintenance company capable of field level maintenance. The organization requires leaders who are oriented towards fighting air and missile battles in the joint operational environment. Figure 4-1 shows an example of an ADA composite battalion organization.

<b>Contents</b>	
Mission.....	4-1
ADA Planning Overview.....	4-4
ADA Task Force Operations.....	4-4
ADA Fire Control Officer.....	4-8

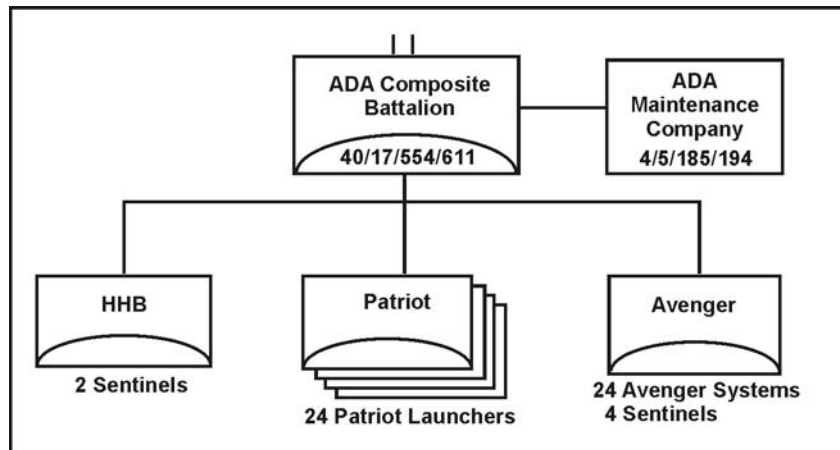

Figure 4-1. ADA composite battalion organization (example)

### Headquarters and Headquarters Battery

4-4. The HHB provides command, control, staff planning, and supervision of battalion operations. It also provides logistical support, unit level health support, and missile resupply operations for the firing batteries. It provides unit maintenance on all assigned equipment except communications, communications security (COMSEC), air traffic control, environmental, and quartermaster equipment. The HHB has a force protection section assigned to conduct coordinated defense of the unit area or unit movements and to provide force protection to subordinate units and missions. The HHB operates the TCS, ICC, and battalion FCC. Figure 4-2 illustrates an example of an ADA composite battalion HHB.

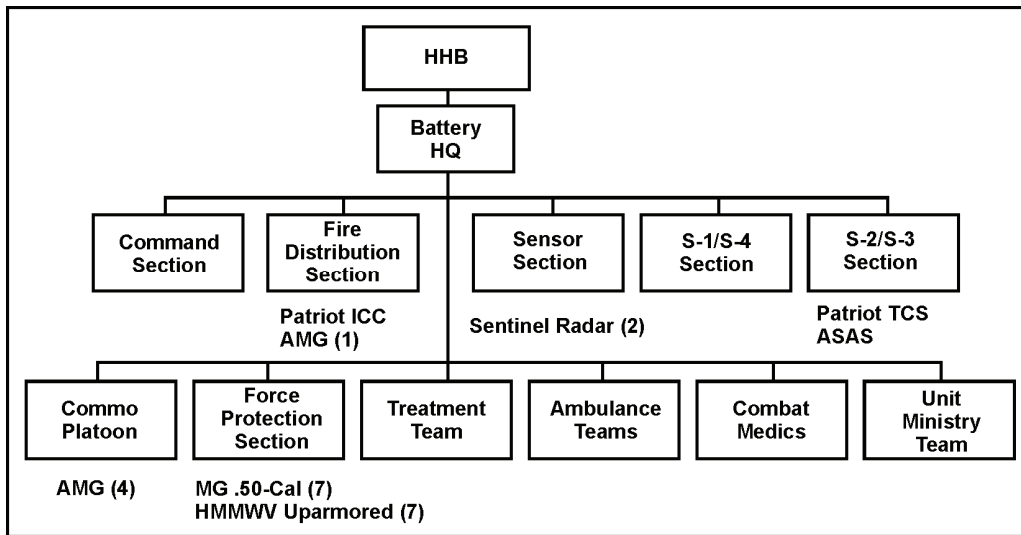

Figure 4-2. ADA composite battalion HHB (example)

### Patriot Battery

4-5. The ADA composite battalion currently has four Patriot batteries assigned. Figure 4-3 illustrates an example of an ADA composite battalion Patriot battery. Each battery provides command and control for employment and firing of six Patriot launchers, operations of the ECS, and provides battery logistical and ammunition resupply support. The Patriot battery relies on the ADA composite battalion HHB for unit



administration, combat health support, religious support, food service support, communications, and quartermaster support.

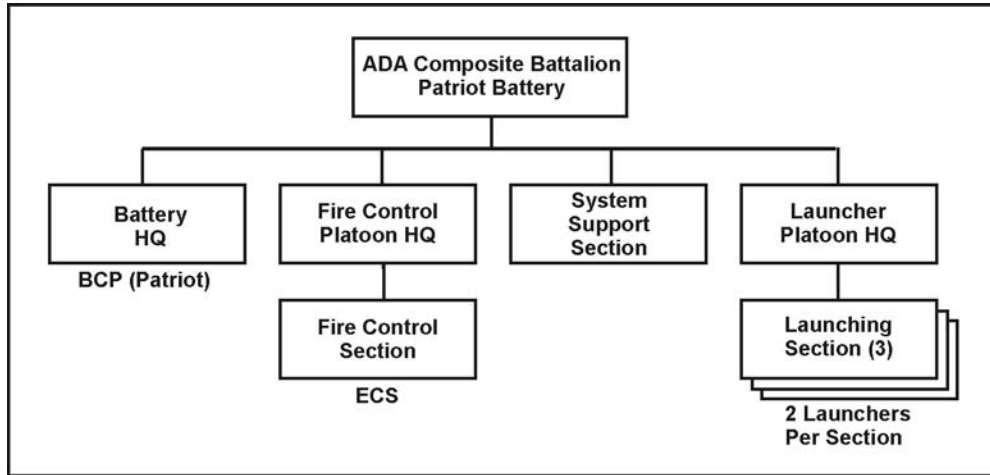

Figure 4-3. ADA composite battalion Patriot battery (example)

**Avenger Battery**

4-6. The ADA composite battalion currently has one Avenger battery assigned. Figure 4-4 illustrates an example of an ADA composite battalion Avenger battery. The Avenger battery provides command and control for the employment and firing of 24 Avenger systems plus four Sentinel radars, and provides battery logistical and ammunition resupply support. The Avenger battery relies on the ADA composite battalion HHB for unit administration, combat health support, religious support, food service support, communications, and quartermaster supply.

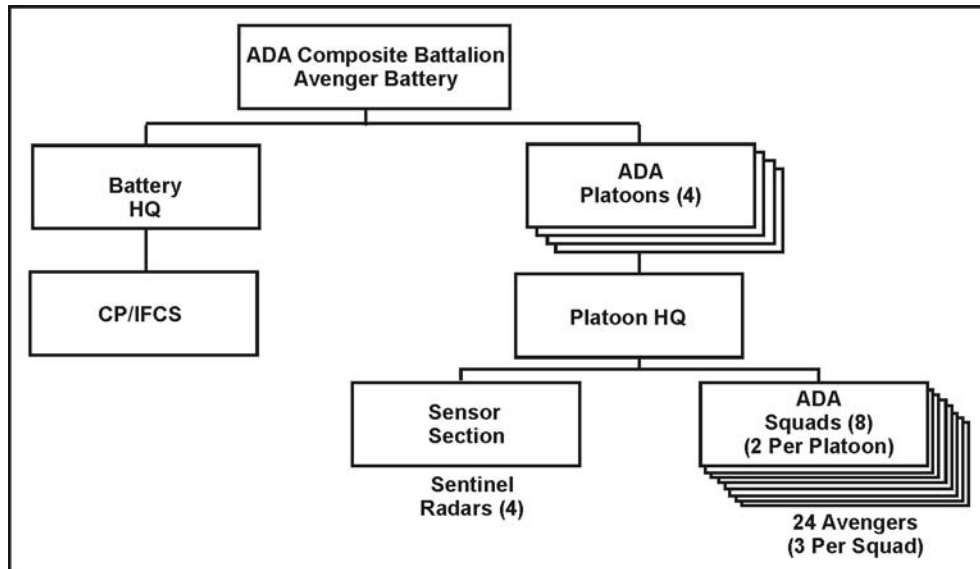

Figure 4-4. ADA composite battalion Avenger battery (example)

## ADA PLANNING OVERVIEW

4-7. ADA planning involves joint, multinational, and Army units including the joint forces command, service or functional component commands, Army Air and Missile Defense Command, the corps, the ADA brigades, and the ADA battalions and batteries. At each level of command, planning begins with the receipt of a mission from higher headquarters and culminates in the issuance of an operations plan, which provides planning direction to subordinate commands. The designation “plan” is usually used instead of “order” in preparing for operations well in advance. An operation plan may be put into effect at a prescribed time, or on signal. It then becomes the operation order.

4-8. ADA planning is performed concurrently at all echelons, a process known as “parallel planning.” The planning process performed at each echelon as well as the planning products exchanged between echelons is summarized in the paragraphs below.

## ADA TASK FORCE OPERATIONS

4-9. In theaters where the threat includes a mix of MRBMs, SRBMs, other TMs, and aircraft, an ADATF may be employed to protect forces and high-value assets. An ADATF can be comprised of a THAAD battery and an ADA composite battalion under the control of a task force TOC (Patriot ICC/TCS), as shown in Figure 4-5. The ADATF may also include Avenger units.

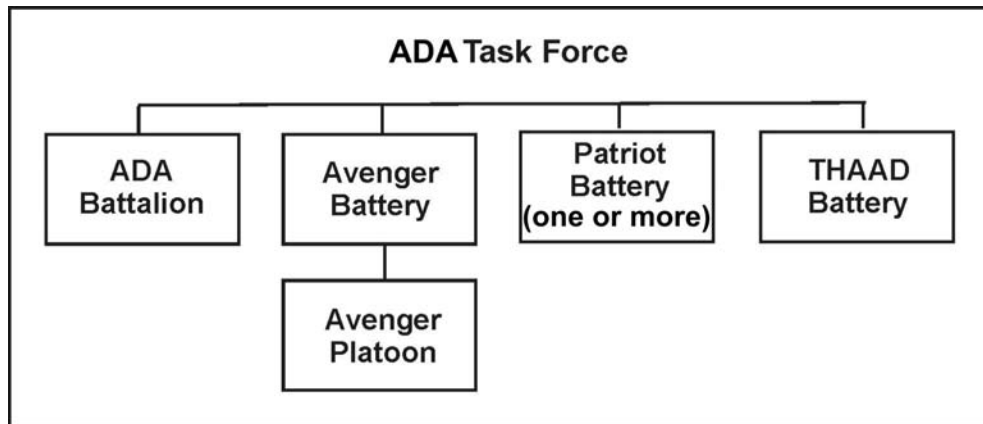

**Figure 4-5. ADATF organization (example)**

4-10. The primary advantage of an ADATF is that it provides a higher level of protection than is achievable with a single system. The THAAD and PAC-3 weapon systems will provide a two-tier defense for high-value assets located under their protective envelope that denies the enemy a preferred attack option. THAAD provides the upper-tier defense against MRBMs and is needed to provide near-leak-proof defense against SRBMs in the common target set, while Patriot provides the lower-tier defense against SRBMs, other tactical missiles (CMs and ASMs), and aircraft. TBM tracks are handed off to the lower tier by THAAD in time for Patriot to engage at optimum range and altitude, and to obtain an intercept above a prescribed keep-out altitude, minimizing the effects of weapons of mass destruction. Avenger units supplement lower-tier defenses by providing additional protection against low-altitude FW, RW, UA, and CM threats. The Patriot battalion normally provides the task force command and control.

## DEFENSE DESIGN PLANNING CONSIDERATIONS

4-11. To properly implement an ADATF, task force planners should have a detailed knowledge of the threat. They must also understand the capabilities and limitations of all systems that comprise the task force and have a working knowledge of THAAD, Patriot, and Avenger units’ system software and communications. Planners should refer to applicable manuals for technical details and specifics on system performance and software capabilities and limitations.

4-12. The task force will normally receive the mission, defense priorities, and commander's intent from higher headquarters. After assessing METT-TC and developing a detailed intelligence preparation of the operational environment, planners develop level of protection requirements, taking into consideration the joint force commander's defended asset list and criticality, vulnerability, and threat assessments. The level of protection requirements drives the allocation and positioning of resources as well as system initialization, firing doctrine, and integration of fires.

4-13. TF planning requires cooperation and close coordination among Patriot, THAAD, and Avenger unit planners. In planning TF defenses, THAAD defense design is first developed. This involves determining the upper-tier search requirements, establishing the primary target lines (PTLs), determining the optimum FU location, emplacing the radar and launchers, and planning communications links within and external to the THAAD battery, including linkage with the ADATF TOC. Planners next develop the Patriot defense design, which involves determining the lower-tier search requirements, establishing PTLs, emplacement of the radar, LCSs and launchers, and planning communications links within and external to the Patriot battalion.

4-14. This planning results in an ADATF defense design, as illustrated in Figure 4-6. This example shows five Patriot FUs and a THAAD FU. The THAAD FU is capable of defending selected assets against MRBMs and most SRBMs. Normally, THAAD is initialized to protect the lower-tier Patriot FUs.

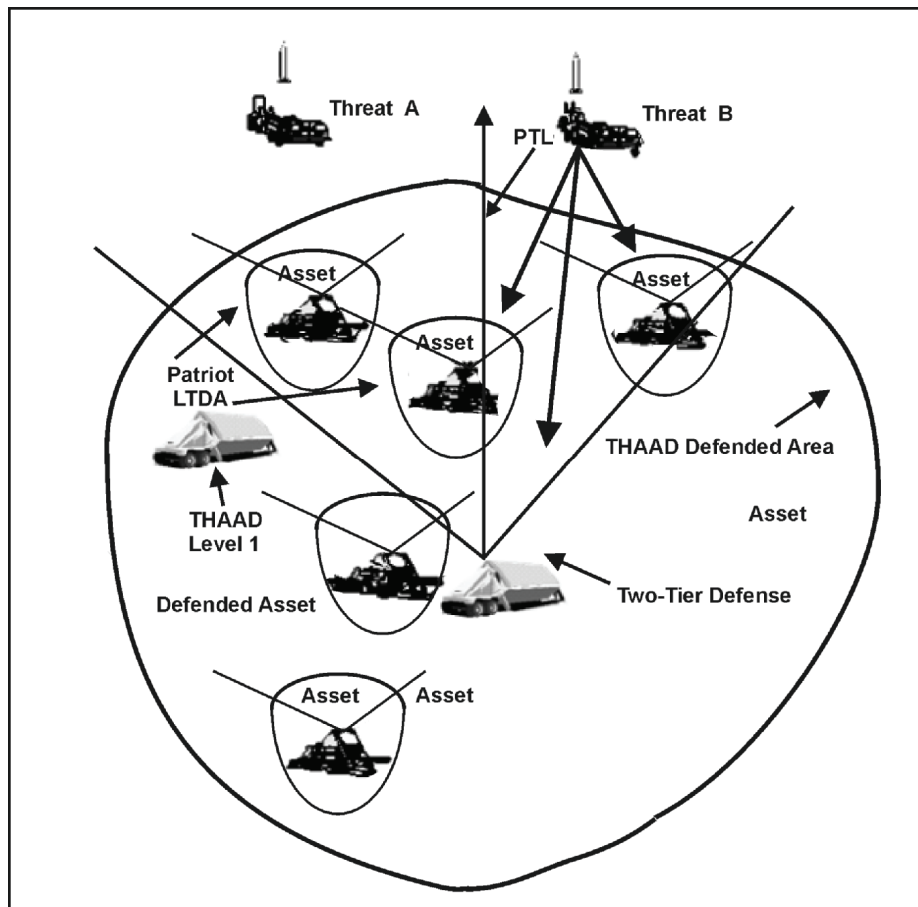

Figure 4-6. ADATF defense design considerations (example)

4-15. The Patriot FUs are capable of defending selected assets within their respective lower-tier defended areas (LTDA). An LTDA is defined as a two-dimensional, multisided area that represents a region where Patriot has both defended assets and engagement capability against TBMs. LTDA coverage is a function of

a number of factors including the type of threat, threat location, threat attack vectors, FU PTLs, Patriot missile type, and remote launcher placement. An LTDA can be extended or enlarged using Patriot's RL-3 remote launch capability.

## COMMUNICATIONS

4-16. The Patriot battalion may be task-organized with THAAD and/or Avenger units, forming ADATF. The ADATF uses a variety of communications networks to accomplish its mission. These networks, shown in Figure 4-7, include the joint data network (JDN), the joint engagement coordination network (JECN), the joint mission management network (JMMN), and UHF and other voice nets. The JDN, JECN, and JMMN are Joint Tactical Information Distribution System (JTIDS) communications networks that disseminate TADIL-J data messages.

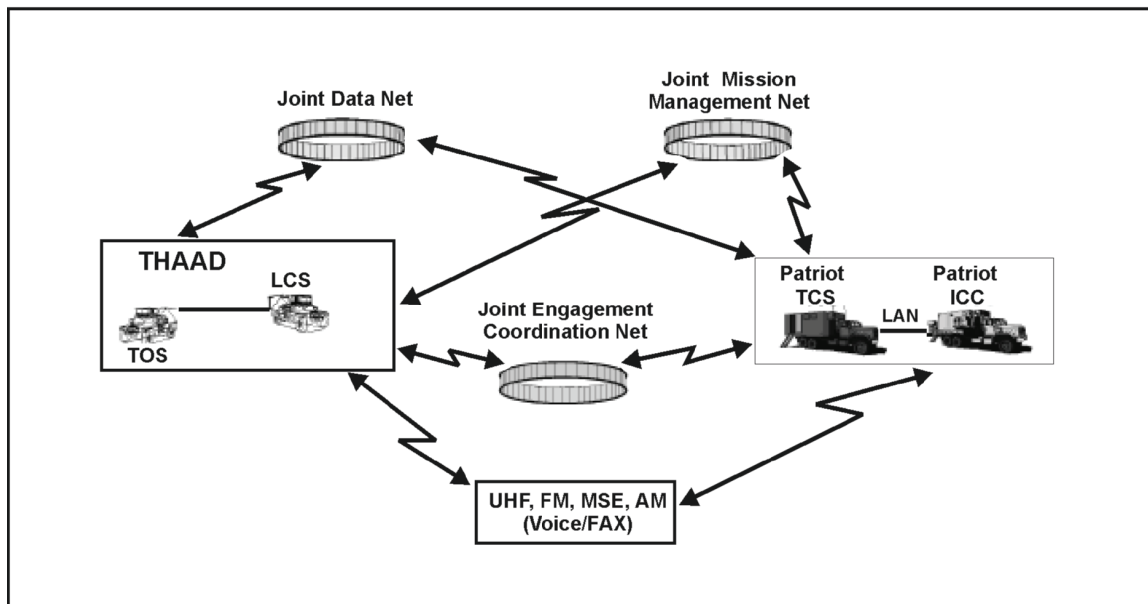

Figure 4-7. ADATF communications networks

### Joint Data Network

4-17. The JDN is used to disseminate near-real-time surveillance and precise participant location information. It is used by the ADATF primarily for exchanging air and missile track data. The specific messages used in ADATF operations are shown in Figure 4-8. These messages are associated with network participation groups (NPGs) 6.7. (See CJCSM 6120.01D for discussion of NPGs and TADIL-J messages.)

### Joint Engagement Coordination Network

4-18. The JECN is used to disseminate near-real-time engagement coordination information. It is used by the ADATF primarily to coordinate engagements between Patriot and THAAD. The specific messages used by the ADATF are associated with Patriot external communications.

### Joint Mission Management Network

4-19. The JMMN is used to disseminate near-real-time mission management information. It is used by the ADATF and THAAD to disseminate commands, engagement status, and ICC/ECS operational status. It also serves as a C<sup>2</sup> link with higher headquarters and joint agencies.

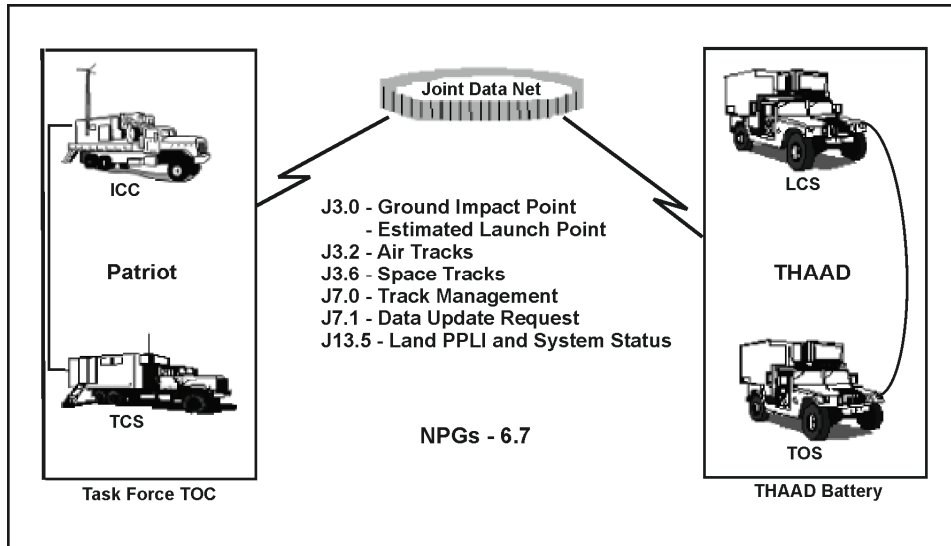

Figure 4-8. JDN, JECN, and JMMN

**UHF Voice, ACUS, and SINGGARS Nets**

4-20. The UHF voice net, shown in Figure 4-9, provides the primary communications for coordinating ADATF engagement and force operations activities, including engagement coordination, defense design, firing doctrine, system initialization, and sensor orientation, with TF elements. The SINGGARS net is a frequency modulation (FM) net used for backup C<sup>2</sup> within the ADATF. The area common user system (ACUS) net is also used to coordinate force and engagement operations activities.

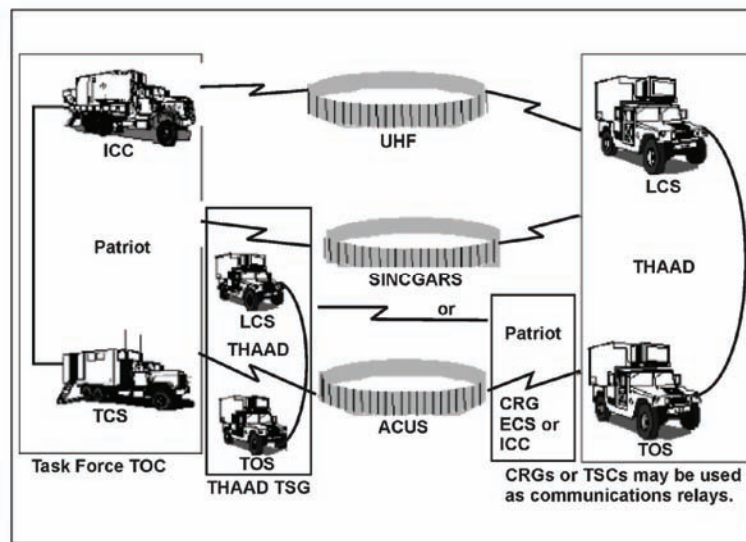

Figure 4-9. Mobile subscriber equipment and voice nets

**Commander's Tactical Terminal-Hybrid**

4-21. A commander's tactical terminal-hybrid (CTT-H) is installed in the TCS and ICC. The CTT-H is a special purpose receiver that allows Patriot to receive intelligence information from various intelligence

sources within theater. The CTT-H allows tactical information broadcast service (TIBS) data to be displayed in the TCS and ICC for SA and planning purposes.

## **ADA FIRE CONTROL OFFICER**

4-22. The ADAFCO is responsible to the senior director for coordinating air defense of designated facilities and areas. He is also responsible for coordinating and monitoring the command, air picture, and fire unit exchange between the control and reporting center/Airborne Warning and Control System (AWACS)/Aegis/tactical air operations center and the Patriot ICC or the ADA battalion FCC.

4-23. An ADAFCO is required in any regional/sector air defense command in which an Army air and missile defense capability is employed. The ADAFCO has the expertise to advise the regional air defense commander (RADC)/sector air defense commander (SADC) on what course of action Army AD units would likely follow during nonstandard situations, especially with degraded communications, what limitations rules of engagement can have on autonomous Army ADA units, what tactics may be more effective, et cetera. ADAFCO elements should be part of liaison to any of the Service AMD operations centers that may have control of or support from Army ADA assets. Typically, an ADAFCO element deploys to the appropriate air defense region or sector location and is responsible to the RADC/SADC for integrating Army AMD capabilities into that part of the Integrated Air Defense System. The ADAFCO must have access to dedicated AD communications links (for example, dedicated AD voice circuit) and with Army AD C<sup>2</sup> nodes when conducting active air defense operations. Unless very unusual circumstances dictate, an ADAFCO should not be placed on an airborne warning and control/airborne command and control aircraft that is not a full-time SADC directing ground-based AD in conjunction with active air intercepts. Those aircraft normally lack dedicated seat positions and communications for the ADAFCO and do not have as reliable SA available as does a RADC/SADC with a tactical data link and a common tactical picture or a common operational picture (COP).

## Appendix A

# Sentinel Radar Systems

This chapter describes the Sentinel radar sensor systems, AN/MPQ-64, and Improved Sentinel, AN/MPQ-64A1, and their role as air defense surveillance and target acquisition/tracking sensors for ADA weapons in the division and corps area. The Sentinel also sends air tracks to the ADAM cell to provide early warning. The Sentinel's accurate and quick-reacting capability enables ADA weapon systems to acquire targets sufficiently beyond the forward line of own troops, thus reducing reaction time and allowing engagement at optimum range.

### MISSION

A-1. Sentinel's mission is to alert, or cue, the Patriot, Avenger, and MANPADS Stinger teams of hostile aircraft, to protect forces from fratricide, and to provide an air picture and situational data to the C<sup>2</sup> centers. Sentinel contributes to the digital battlefield by automatically detecting, tracking, classifying, identifying, and reporting targets infiltrating below the umbrella provided by long and medium air defense sensors.

A-2. The Sentinel is deployed with FAAD units of the U.S. Army and U.S. Marine Corps. It is a mobile, compact, modular, multifunctional phased-array radar. The Sentinel is designed with high resistance to ECM capabilities, and performs target acquisition, tracking, and identification.

### DESCRIPTION

A-3. The Sentinel consists of a radar antenna unit mounted on top of the transceiver unit. The radar antenna unit also includes an IFF interrogator, an IFF antenna, and an auxiliary ECCM antenna mounted on a single pedestal that rotates during operation. The antenna unit is lowered by hand crank to the stowed position for road march.

A-4. The Sentinel is a state-of-the-art three-dimensional (3-D) battlefield radar sensor using modern phased-array antenna technology and IFF system for interfacing with the FAAD C<sup>2</sup> network. Targets can be hovering to fast-moving, or nap-of-the-earth, out to the maximum engagement altitude of the FAAD weapons. Highly mobile and reliable, the Sentinel's antiradiation missile and ECM support the Army corps and divisional AD operations across the full spectrum of conflict.

A-5. Sentinel is designed to operate in clear and obscured conditions, day or night operations, adverse weather, dust, smoke, aerosols, precipitation clutter environments and countermeasures, while providing 360-degree azimuth coverage for acquisition and tracking.

A-6. Sentinel's integrated IFF reduces the potential for fratricide of Army Aviation and Air Force aircraft. An auxiliary ECCM antenna is mounted on a single pedestal that rotates during operation. The antenna unit is lowered by hand crank to the stowed position for road march.

### SUPPORT EQUIPMENT

A-7. The HMMWV is the prime mover and support vehicle for the Sentinel. The HMMWV transports the tactically quiet 10-kw generator, communications equipment, cabling for system power, team tactical gear, water, and rations as shown in Figure A-1. The HMMWV can meet the fuel requirement needs of the 10-kw generator for extended periods of operations by transferring fuel from vehicle to generator by the generator on-board fuel selection switch.

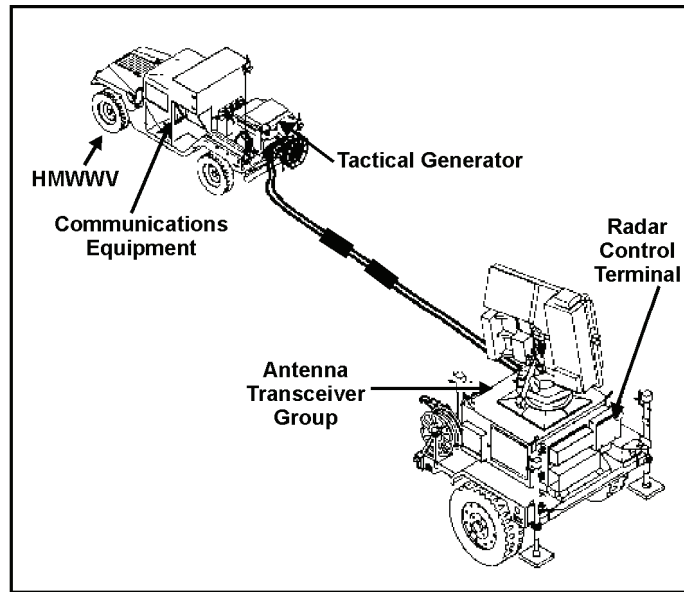

**Figure A-1. Sentinel radar sensor system**

A-8. The remote control terminal (RCT) is a rugged, compact mini-computer with a graphic display screen and multifunction control input keyboard. The Sentinel operator controls the operation of the radar by use of the keypads on the RCT. The RCT can be cable-remoted from the Sentinel to provide real-time tactical air pictures on a graphic display screen at remote locations. Sentinel radar target tracks are displayed to the operator in target symbology that shows range, elevation, velocity, and track number information.

## OPERATING CHARACTERISTICS

A-9. The Sentinel has a search elevation capability of 20- to 25-degree scan and is selectable between -15 and +55 degrees. It can rotate in azimuth 360 degrees clockwise (cw) or counterclockwise (ccw) scan and search a perimeter greater than 40 km. The elevation azimuth beam width track perimeter is -10 through +55 degrees with a 360-degree cw or ccw scan 2- by 2-degree pencil beam 40-km instrumented range.

A-10. The Sentinel is capable of reporting track data as listed below:

- Target tracking in azimuth, elevation, and headings in degrees.
- Ranges in miles or kilometers.
- Altitudes in feet or meters.
- Velocity in feet per second or meters per second.
- Target discrimination, fixed-wing or helicopter unknown, designation.
- Unknown or unknown friendly.
- Jammer discrimination in azimuth, and elevation in degrees or mils.
- Report reference data respective to data link reference point or site Military Grid Reference System/mean sea level.
- Coordinates report capabilities FAAD C<sup>2</sup> and intelligence activities data link to include track report and IFF/selective identification feature report.
- ECM intercept messages over EPLRS radio link to include track report messages via SINCGARS radio link and track report messages.

A-11. The Sentinel operates in the X Band with a 3-D pencil beam and range-gated, pulse Doppler radar.



A-12. The FAAD data link (FDL) interfaces with SINCGARS along with the EPLRS PLGR/JTIDS hybrid interface and is hardwired to command and control.

### RADIO FREQUENCY HAZARD

A-13. An RF radiation hazard condition exists for fixed-beam operation (antenna not rotating). No personnel will be within 800 mils left or right of frontal area of antenna for a distance of 50 meters when system is radiating while not rotating.

### RADAR SENSOR CHARACTERISTICS

A-14. Sentinel's characteristics are shown in Table A-1.

**Table A-1. Sentinel characteristics**

<b>Height</b>	
Antenna erected	131.7 in
Antenna stowed	94.8 in
<b>Width</b>	
Mirrors folded	85 in
Length	167.26 in
Length with HMMWV	312 in
Weight	3,740 lb
<b>Temperature</b>	
Operating	-50° to 125° F (-46° to 52° C)
Non-operating	-70° to 160° F (-57° to 71° C)
<b>Altitude</b>	
Operating	Up to 10,000 ft
Non-operating	Up to 50,000 ft
<b>Weather</b>	
Wind velocity:	
Operating	0 to 52 mph with gusts to 75 mph
Non-operating	52 mph with gusts to 100 mph
Rain	5 in/hr
<b>Electrical Requirements</b>	
Voltage	208 VAC + 10% 3-phase; 120 VAC + 10%
Power	10 kw, 400 Hz
<b>Mobility/Transportability</b>	
Graded gravel road	30 mph
Cross-country terrain	8 mph
Side slope	20%
Longitudinal slope	32%
Fording	up to 30 in deep

### METHODS OF EMPLOYMENT (A AND B)

A-15. Method A: Sensor sections are deployed by the sensor platoon leader with staff supervision exercised by the AD battalion S-3. The S-3 coordinates the selected map positions with the division AC<sup>2</sup> cell. In this method, the platoon leader retains control of the sections.

A-16. Method B: Two sensor teams are assigned to each firing battery. The firing battery recommends sensor positions to the ABMOC officer in charge. The S-3 coordinates these positions with the battalion S-2 and division air defense and air space management (ADAM) cell. The S-3 recommends approval or changes and forwards the approved positions to the firing battery commander.

A-17. The AD battalion commander must consider certain deployment factors to determine which of the two methods (A or B) to consider. These factors include, but are not limited to or affected by, the following:

- Mission.
- Deployment of supported forces.
- Deployment of fire units.
- The enemy threat (air and ground).
- Terrain.
- Electronic warfare environment.

## **IMPROVED SENTINEL RADAR SENSOR**

A-18. The mission of the Improved Sentinel radar sensor (AN/MPQ-64A1) is much the same as the AN/MPQ-64 Sentinel. Additional information for the AN/MPQ-64A1 Sentinel radar can be found in TM 9-1430-741-10.

### **NORMAL OPERATION**

A-19. Normal operation of the A1 is controlled at the FAAD C<sup>2</sup> control point. Once the A1 is turned on and initialized, the operation of the A1 is automatic. Target data and target classification data are supplied automatically to a data link.

A-20. During normal operation, the A1 is controlled by the operational program software loaded into the A1 computer. In the operational program, the computer commands a continuous 360-degree (6,400-mil) search. When detection is received, a verification beam is sent at the azimuth of detection. If another detection is made at the same range, the computer commands the beginning of the track mode for that target, while continuing the search mode over the rest of the search sector.

### **RADAR COLLECT AND PROCESS CYCLES**

A-21. In the collect cycle, the transmitter and receiver are active, and radar detections are made and stored.

A-22. During the process cycle, the stored radar data is processed to determine targets.

A-23. Collect and process cycles occur at the same time. However, the collect cycle is for the current radar beam, whereas the process cycle is for the previous beam. The computer processes data continuously and operates on data that is input from the A1 during the process cycle.

### **EQUIPMENT FEATURES**

A-24. The A1 consists of an ATG and HMMWV M1097. The ATG includes the antenna-transceiver and the sensor interface unit mounted on a modified HMMWV trailer. The antenna-transceiver contains all radar microwave generation, transmission, and receiving components.

A-25. The sensor interface unit contains circuits and components for radar control, signal and data processing, and communication interface.

A-26. The major differences between the AN/MPQ-64 and the AN/MPQ-64A1 are listed below:

- Transmitter blower.
- Low-voltage compartment.
- Power amplifier module compartments.
- Receiver/exciter compartment.

Figure A-2 shows the A1, curbside and roadside, respectively.

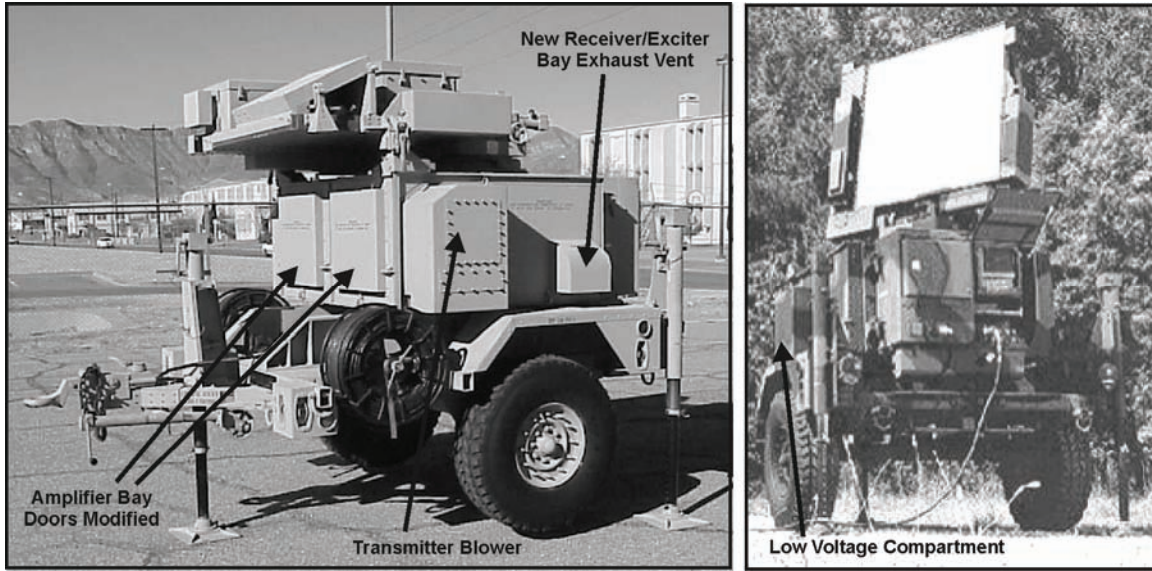

**Figure A-2. Improved Sentinel, AN/MPQ-64A1**

---

Note: It is imperative that AD battalion commanders and operators know the capabilities, limitations, and characteristics of the Sentinel radar systems.

---

**This page intentionally left blank.**

## **Appendix B**

# **Air Defense and Airspace Management Cell**

This appendix provides an overview of the ADAM cell operations. It discusses its mission and role in the force protection cell, AC<sup>2</sup>, and airspace management. It also describes the roles that the ADAM cell plays in supporting various missions and the equipment required. Additional information can be found in FMI 3-01.50.

### **MISSION**

B-1. The ADAM cell deploys worldwide with the corps, division, BCTs (Heavy Brigade Combat Team [HBCT], Infantry Brigade Combat Team [IBCT], and Stryker Brigade Combat Team [SBCT]) to: plan; coordinate; and establish connectivity with JIM sensors and C<sup>2</sup>, communications, computers, and intelligence activities/controller networks, as well as airspace users. ADAM cell also provides SA and early warning, conducts continuous planning and execution of airspace management requirements for the supported unit/echelon, and conducts AMD and Aviation planning and coordination to determine ADA and Aviation requirements across full spectrum operations.

### **ROLE**

B-2. The ADAM cell is integrated into the three echelons in the Army's transformation to the modular "brigade-based" Army. These three echelons are the higher echelon units (corps and division), the BCTs (Infantry, Heavy, and Stryker) and the support brigades—Combat Support Brigade (CSB) Maneuver Enhancement (ME), Battlefield Surveillance Brigade (BFSB), Aviation, Fires, and Sustainment—as explained below:

- Corps and division are provided with an ADA cell as follows:
  - Corps: A corps air defense element is positioned in the TAC CP. Additional ADA personnel are positioned in the Corps Main CP.
  - Division: A division air defense element is positioned in both the Division Main CP and TAC CP.
- Brigade combat teams:
  - The Infantry, Heavy, and Stryker BCTs are provided with an ADAM/Brigade Aviation Element (BAE) cell. This element combines ADA and Aviation personnel.
- The support brigades are provided with a support air defense element.

### **AUGMENTATION**

B-3. Although each of these cells is fielded with the same equipment (AN/TSQ-282 with common equipment), the manning and placement within the headquarters staff section is different in each case. Their functions include the following:

- Conduct ADA augmentation planning and coordination.
- Conduct Aviation augmentation planning and coordination.
- Conduct risk management to minimize the potential for fratricide (air/ground positive/procedural identification, et cetera) for the BCT.
- Provide early warning of enemy aerial attack.
- Develop, display, and disseminate the common operational picture and single integrated air picture to the BCT to provide SA and facilitate SU.

- Contribute to AC<sup>2</sup> planning and execution.
- Contribute to joint/local airspace deconfliction.
- Contribute to operational protection.
- Advise and update the commander on adjacent ADA unit location, plans, and intent.
- Take responsibility for the continuous assessing of ADA augmentation requirements.
- Identify the sensor requirements for the commander during development of the ISR collection plan.
- Integrate operations using the Army Battle Command System (ABCS) (Advanced Field Artillery Tactical Data System, AMDWS, All Source Analysis System, Force XXI battle command—brigade and below, Global Command and Control System-Army, maneuver control system, and Tactical Airspace Integration System [TAIS]) with JIM units/organization.
- Request, maintain, and disseminate AC<sup>2</sup> measures or restrictions.

## REACH

B-4. The ADAM/BAE cell (HBCT/IBCT) and ADAM cell (SBCT) equipment provides the commander at all echelons with the force multiplier of “reach.” Reach is the ability of a deployed military force to rapidly access information, conduct collaborative information-sharing with, and receive support from, other units deployed in-theater but not in the chain of command and from out of theater assets unconstrained by geographic proximity, echelon, or command relationship. The capability for reach enhances its force effectiveness by allowing the commander and staff to exploit a multitude of non-organic resources to accomplish assigned missions.

B-5. The staff executes reach on a routine, deliberate basis as a combat power and sustainment multiplier in five primary areas:

- Fires.
- Intelligence and information.
- Planning and analysis.
- Protection.
- Sustainment.

B-6. In addition to enhancing the staffs’ ability to accomplish their assigned mission, reach also enhances its operational agility. Reach is executed primarily through Army forces, although the Army forces may authorize direct linkages between the unit and resource providers when it is prudent and efficient to do so. Staffs must understand the capabilities available through reach and how best to employ them for mission success.

B-7. Reach allows the supporting headquarters to provide detailed analytical support to the unit commander and staff. This support includes anticipating and initiating collection against long lead-time requirements, synthesizing available information on the area of operation, and orchestrating the collection efforts of existing intelligence organizations and sophisticated computer analysis of a course of action (COA) to help speed the military decision-making process. The degree of support needed depends on the factors of METT-TC and should be tailored, as the operation develops, to ensure seamless intelligence support. Figure B-1 depicts the reach provided by the ADAM/BAE cell (HBCT/IBCT) and ADAM cell (SBCT) and the degree of interoperability.

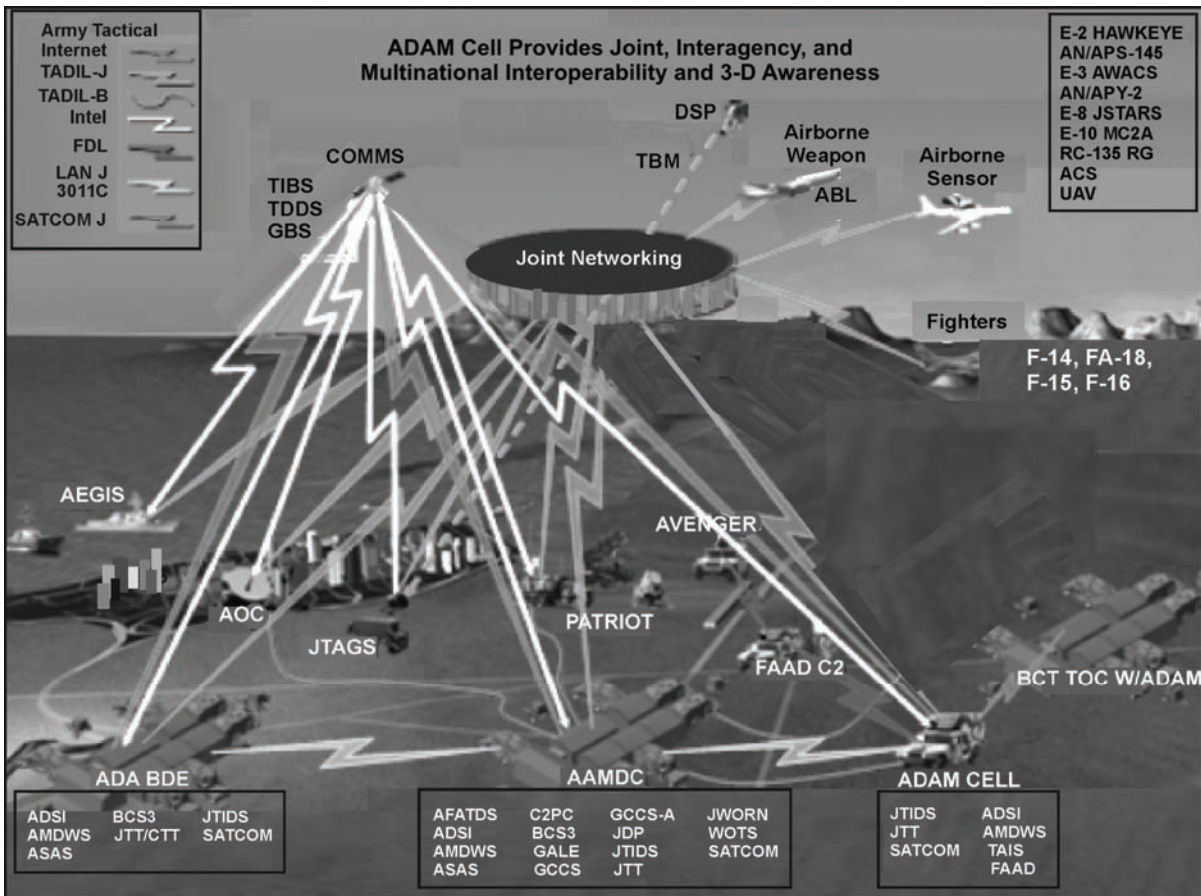

Figure B-1. ADAM cell interoperability

## ENHANCED SITUATIONAL UNDERSTANDING

B-8. The ADAM/BAE cell (HBCT/IBCT) and ADAM cell (SBCT) employ a multilevel, integrated suite of ABCS surveillance assets to develop and share a COP throughout the force. These information systems provide the commander with a unique capability to visualize, describe, and direct the unit through full spectrum operations and terrain in which the unit may be operating.

B-9. The COP is an operational picture tailored to the commander's requirements for information of friendly forces, enemy forces, and terrain. It is based on common data and information shared with subordinate or adjacent commands. Analysis of the COP, together with a commander's application of experience, expertise, intuition, and judgment, establishes a relationship among the factors of METT-TC that leads to SU. SU facilitates decision making by identifying opportunities for mission accomplishment, threats to the force, and gaps in information. Although critical information may be available via national and theater reach assets, the ADAM/BAE cell (HBCT/IBCT) and ADAM cell (SBCT) are a major resource for providing data and combat information to build the knowledge base necessary for the unit to achieve SU.

## JOINT, INTERAGENCY, AND MULTINATIONAL INTEROPERABILITY

B-10. Although the unit is expected to always operate under Army forces command, the operational environment may require it to maintain direct links with multinational forces and U.S. and foreign

governmental and nongovernmental organizations involved in the conflict, crisis, or instability. In many situations, the unit will benefit from exploiting the knowledge and capabilities residing within these organizations. Effective interaction is especially important in an environment where the adversary is primarily employing unconventional capabilities rather than conventional military power to achieve an end. In some circumstances, the unit headquarters or subordinate elements actively participate in civil-military operations. Interoperability with these organizations is essential and is best facilitated through the exchange of a liaison officer. The fact that the unit communications systems may not be compatible with the JIM organization increases the need for an exchange of knowledgeable liaison officers properly equipped to communicate according to the TOE. (See Figure B-1.)

## FULL SPECTRUM OPERATIONS

B-11. The ADAM/BAE cell (HBCT/IBCT) and ADAM cell (SBCT) are manned and equipped to conduct operations in an operational environment. However, conditions may develop that require added capabilities not resident within the BCT. When the BCT participates in a major combat operation, it will do so as a subordinate element of a division or corps. Its mobility and organic ISR assets make it invaluable to a division or corps commander in a major combat operation. As with any brigade, adjustments to task organization may be required. Likely additions to the BCT task organization may include aviation, armor, engineers, and air and missile defense.

## ADAM CELL EQUIPMENT

B-12. The ADAM cell is used at the SBCT and the support brigades CSB (ME, Aviation, Fires, Battlefield Surveillance, and Sustainment). The ADAM cell is used in conjunction with the BAE at the IBCT and the HBCT and is at the corps, division, and Army headquarters level. The equipment (hardware and communications) within the ADAM cell is described here, as well as system hardware capabilities.

## ADAM CELL HARDWARE

B-13. The ADAM cell is comprised of a prime mover, an AN/TSQ-253 shelter, and power generation equipment with trailer. See Figure B-2.

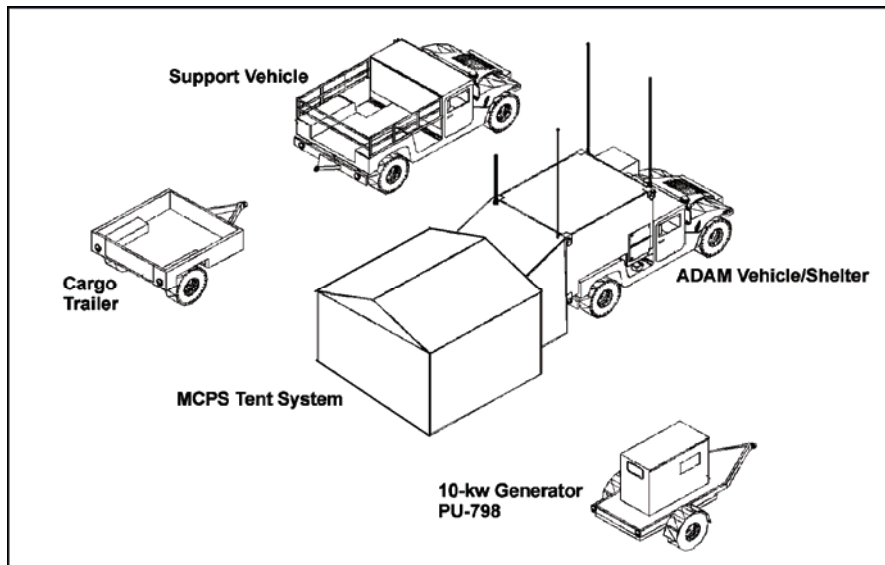

Figure B-2. ADAM cell



## Prime Mover

B-14. An M1113 heavy chassis HMMWV transports and serves as the bed for the ADAM cell shelter. This vehicle has a stronger load and pulling capacity than the standard HMMWV. The rigid wall shelter (RWS) protects ADAM cell personnel from CBRN attacks and has power, local area network (LAN), and antenna connections on both sides of the structure.

## Shelter

B-15. Standardized integrated command post system RWS is a transportable HMMWV-mounted shelter integrated with ECU, electromagnetic interference and circuit breaker protection, equipment racks, and power/signal wiring. Figures B-3 and B-4 illustrate the ADAM command post platform (CPP) layout aboard the HMMWV.

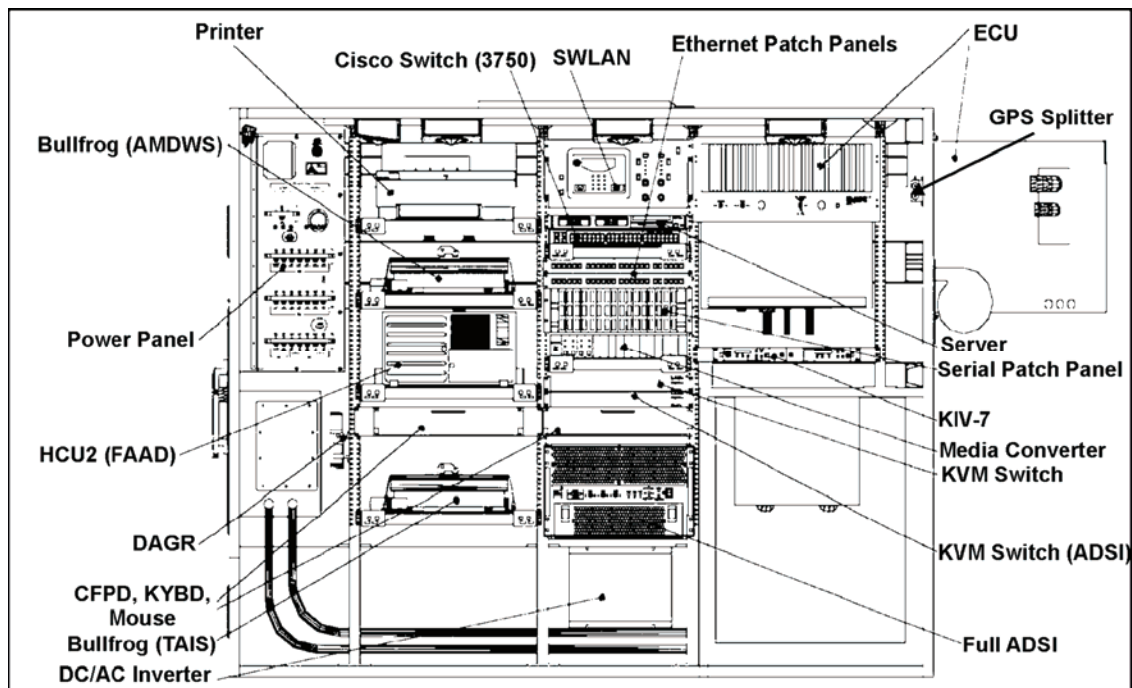

Figure B-3. Roadside equipment in CPP ADAM cell

## Roadside Equipment in the Command Post Platform

- Bullfrog laptop—Solaris/Unix and Windows-based operating system laptop capable of FAAD C<sup>2</sup> and intelligence activities. FAAD C<sup>2</sup> and intelligence activities provide the capability to manage air defense engagements to the cell.
- Sun processor console—keyboard/mouse and display for FAAD C<sup>2</sup>, intelligence activities, and AMDWS.
- Defense advanced global positioning system receiver—provides precise positioning service support and position, velocity, navigation and timing to all missions that involve land-based war-fighting operations.
- Printer—network printer for the CPP ADAM cell.
- Cisco switch (3750)—hubs for the CPP ADAM cell's primary LAN.
- Secure wireless LAN—wireless LAN component for continuity of LAN while on the move and the initial LAN prior to wire being emplaced.
- ECU—maintains correct operational temperatures for the equipment inside the CPP shelter.

- Server—Windows server used at the discretion of the user. Can act as exchange server for the unit or as an additional network storage component.
- Serial patch panel—physically transfers data to multiple components of the CPP ADAM cell.
- KIV-7—Embeddable KG-84 COMSEC modules cryptographic devices that provide protection for digital and voice communications.
- Media converter—gigabit Ethernet copper-to-fiber converters combine existing 100-meter category-5(E) UTP and fiber-optic segments to deliver gigabit data across the network.
- Keyboard-video-mouse for Processor—keyboard, video, mouse processor for the Sun processor.
- Air defense system integrator (ADSI)—provides three functions for the ADAM cell:
  - A routing capability to support the following TADILs: B Link 11B, and J Link 1.
  - The capability to receive intelligence information from the Integrated Broadcast System (IBS), specifically TIBS and Tactical Data Distribution System (TDDS).
  - A set of air defense command and control functions to the crew.

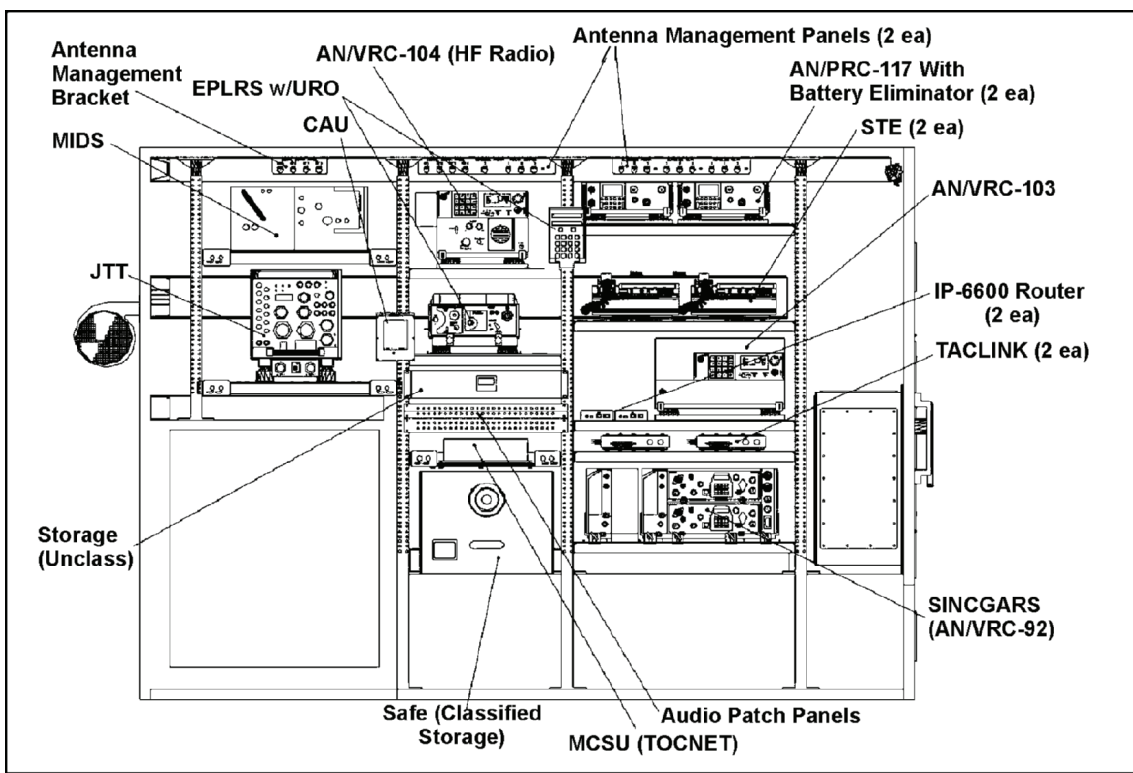

Figure B-4. Curbside equipment in the CPP ADAM cell

**Curbside Equipment in the Command Post Platform**



- Joint tactical terminal (JTT)—provides access to the IBS system via TIBS and TDDS.
- Multifunction Information Distribution System (MIDS)—provides access to the TADIL-J (Link 16) data network for the receipt of air tracks.
- Crew access unit—the primary man-machine interface for the TOC net intercommunication system. Interactive screens are presented to the user on the amber electroluminescent quarter video graphics array display.
- EPLRS—provides robust, on-the-move, high-speed, automated data exchange using a contention-free networking architecture. This guarantees speed of service to time-critical users. with unit readout: EPLRS data input control unit.

- AN/VRC-104—provides command and control capability in the high frequency band. It supports the brigade operations and intelligence net.
- AN/PRC 117 w/battery eliminators—provides command and control capability in the UHF and satellite communications (SATCOM) band. Also used to transmit secure data over the satellite network.
- Secure telephone equipment (STE)—the evolutionary successor to the secure telephone unit Type III (STU-III). The STE program improved secure voice communications by changing out the analog STU-III products with digital-based STE products.
- AN/VRC-103—provides command and control capability in the UHF and SATCOM band.
- IP 6600—industrial rated router featuring two serial ports and two Ethernet LAN ports.
- TAC LINK 2000—provides a modem-like interface for computer workstations employed by joint and allied military services. Allows data transfer to unique military tactical devices used on the emerging digital battlefield.
- SINCGARS—provides VHF-FM (30 to 88 megahertz) combat net radio communication with ECCM capability (frequency hopping) and digital data capability (data rate adapter).
- Micro central switching unit—communications platform that provides the operation center voice/data communication throughout the center.

**Support Vehicle and Trailer**

B-16. An M1097 HMMWV serves as transport and support vehicle for the ADAM cell, along with a high-mobility trailer that can carry a 1¼-ton load. This vehicle carries the bulk of the crew and equipment. See Table B-1. Figure B-5 shows the ADAM cell when remoted from the HMMWV.

**Table B-1. AN/TSQ-282 system capabilities, linkages, and enabling device**

	
<p><b>Communications System</b></p> <p>AN/VRC-90 DAGR</p>	<p><b>Capability</b></p> <p>VHF LOS Voice Position</p>
<p><b>Communications System</b></p> <p>DAGR EPLRS AMDWS EO WS AN/VRC-92 AN/VRC-104(V)3 AN/USC-62 JTT ADSI STE AN/PRC-117 AN/PRC-117 LAN/WAN STE AN/VRC-103 JTIDS/MIDS AN/VRC-92 TOCNet</p>	<p><b>Capability</b></p> <p>Position/Timing FAAD C<sup>2</sup>Data &amp; AP ABCS/ATCCS FAAD Data Link VHF LOS Voice HF BLOS Voice Integrated Broadcast Service Multi-TADIL Processing Network Voice JMTOP SCTACSAT JRE SAT-J JRE Socket-J JRE Serial-J TADIL-A UHF TADIL-J VHF LOS Voice Voice/Data LAN</p>

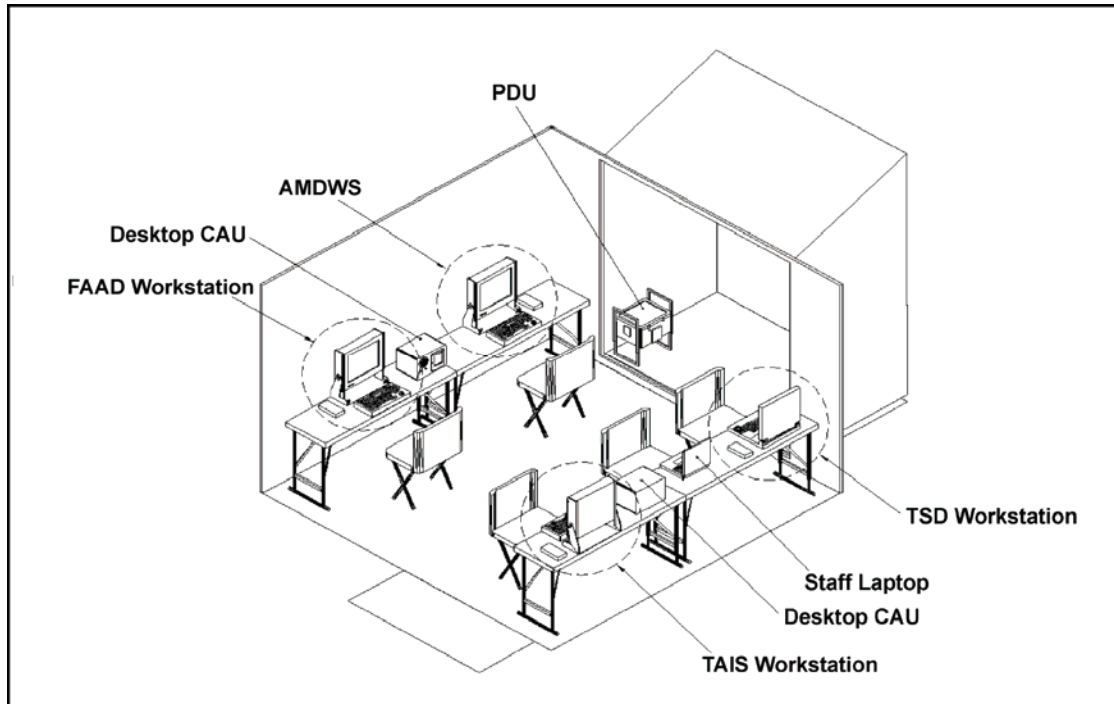

**Figure B-5. ADAM cell remoted from shelter**

### Power Generation

B-17. PU 798 tactically quiet generator (TQG) is a trailer-mounted, 10-kw, 60-Hz generator.

### COMMUNICATIONS EQUIPMENT

B-18. MIDS LVT2/JTIDS is a TADIL J. Link 16 is an improved adaptable link used to exchange near-real-time information and is a communications, navigation, and identification system that supports information exchange between tactical C<sup>2</sup>. These high-capacity UHF line of sight frequency hopping data communications terminals provide secure, jam-resistant digital data exchange. They operate on the principle of time division multiple access, which provides 12-second frames divided into 1535 time slots using 51 frequencies operating between 960 and 1215 MHz in different hopping patterns. The JTIDS terminals provide precise position determination and a positive self-identification. Forces on-the-move benefit from the terminal's flexibility; the omni-directional antenna provides 7.5dB gain around the full 360 degrees of azimuth.

B-19. The advanced system improvement program SINCGARS VHF-FM radio set is compatible with all current U.S. and allied forces VHF-FM. These radios are used for voice or data communications able to communicate in single-channel or frequency hop, in secure or nonsecure mode. They operate between 30 and 88 MHz with a channel separation of 25 kHz, and can change between 100 frequencies per second.

B-20. JTT provides near-real-time tactical intelligence and targeting information, and supplies the critical data link to battle managers, intelligence centers, air defense, fire support, and aviation nodes across all services. The terminals allow Army, Air Force, Navy, and Marine Corps users to exploit TIBS and TDDS. The JTT is a family of special application UHF tactical intelligence terminals which provide the capability to disseminate time sensitive and battlefield targeting information to tactical commanders and intelligence nodes.

B-21. EPLRS is a synchronous time division multiple access system that provides identification, position, location, and navigation information to a centralized net control station automatically. It reports this information to commanders and supported users within the EPLRS community upon request. It provides near-real-time data communications support to weapon system sensors and other battlefield automated systems.

B-22. The Harris AN/PRC-117 covers the entire 30- to 512-MHz frequency range while offering embedded COMSEC and Have Quick I/II ECCM capabilities. This advanced software reprogrammable digital radio provides 20 watts FM and 10 watts AM transmit power along with Have Quick I/II capability in the UHF band. The system is fully compatible with the TSEC/KY-57 in voice and data modes, including full transmit and receive SARK operations mode. Radio operating parameters and status can be accessed through the remote control capability of the radio. The asynchronous remote control data interface is either RS-232E or RS-422. A built-in-test feature checks system performance down to the module level.

B-23. The Harris AN/VRC-103 multiband, multimission vehicular radio system includes an AN/PRC-117F multiband, multimission tactical radio and the AM-7588 multiband power amplifier. This system covers the entire 30- to 512-MHz frequency range offering 50 watts PEP transmit power, embedded COMSEC, SATCOM, and ECCM capabilities. Fully compatible with the TSEC/KY-57 and the advanced narrowband digital voice terminal/KYV-5 in voice and data modes, the AN/VRC-103 (V) 1 is also compatible with Fascinator equipment in voice mode and the KG-84C in data mode. Transmit and receive SARK operations are fully supported for each COMSEC interoperability mode. The radio supports both DS-101 and DS-102 fill interfaces and all common fill devices. It also supports a KY-57/VINSON compatible interface to ease backwards interoperability with fielded equipment. An embedded demand assigned multiple access and SATCOM modem complies with MIL-STD-188-181B, -182A, and -183A and is software reconfigurable to accommodate changes to these standards. An external GPS interface accepts time and position data. The radio is interoperable with both the SINCGARS and Have Quick I/II ECCM operations in voice and data modes.

B-24. The Harris AN/VRC-104 is an advanced high frequency radio which operates from 1.6 MHz to 29.9999 MHz using sky wave (upper side band, lower side band, continuous wave, and amplitude modulation equivalent) modulations with selectable low (1.0 watts), medium (5.0 watts), and high (20.0 watts) output power. It operates from 20.000 MHz to 59.9999 MHz in FM with maximum power of 10 watts.

B-25. Secure terminal equipment nonsecure voice: telephone service interoperable with conventional integrated services digital network and public switched telephone network telephones, STE, and STE and STU-III terminals, narrowband devices and digital nonsecure voice terminal. Secure voice: interoperable with other STE, STU-III, or OMNI terminals. Secure facsimile: interoperable with units supported by other STE, STU-III, or OMNI terminals. Secure data: interoperable with units supported by other STE, STU-III, or OMNI terminals.

B-26. AN/PSN-13, defense advanced GPS receiver (DAGR) is a self-contained, hand-held, 12-channel, dual-frequency GPS receiver. It uses next-generation GPS receiver technology including "all in view" satellite tracking and the Selective Availability Anti-Spoof Module (SAASM) device to access the precise positioning service signal. The DAGR is 3.5" wide by 6.5" high and weighs just under 1 pound with batteries. It provides highly accurate position, velocity, and timing data to individual warfighters and integrated platform users. When operated with COMSEC, the DAGR provides enhanced anti-spoof and anti-jam protections. The DAGR supports position location, target location, rendezvous and enroute and terminal navigation. The DAGR is the replacement for the PLGR, a 5-channel GPS receiver first fielded in 1994. The DAGR will provide ICD-GPS-153 and NMEA 0183 compliant serial data interfaces for weapon system integrations. The DAGR will be delivered with a multi-year manufacturer's warranty and will be backward compatible with PLGR. Weapon system managers will develop installation kits for specific platforms.

### Antennas

B-27. JTIDS (VHF/UHF, JTIDS, and UHF SATCOM systems): Unique capabilities include high power (10,000-watt average) capable antennas, multiband (VHF through L-Band) apertures, as well as rapid-erection UHF SATCOM antennas for fixed and portable deployments.

B-28. OE-254 is a bi-conical antenna that uses a BALUN (balanced/unbalanced) transformer to match the 50-ohm coax line and radio to the 200-ohm antenna. It covers the 30- to 88-MHz frequency range without any element adjustments and, therefore, is said to have an instantaneous bandwidth. The OE-254 was designed for frequency hopping and conventional radios and will work anywhere in the 30- to 88-MHz bandwidth.

B-29. Quick-erect antenna mast (QEAM) is a manual, screw-drive mast which holds up to a maximum 50 pounds (23 kg) of payload and extends to a maximum 50 feet (15 m). The QEAMs are available with or without integrated antennas and can be vehicle-, shelter-, or ground-mounted. In addition, guy lines, guy stakes, and erection tools, optional mounting brackets for HMMWV variants, armored personnel carriers, and shelters are available.

B-30. SATCOM antennas are as described below:

- AV 2040 is a foldable, manpack, high gain, and UHF SATCOM antenna designed for special missions where portability and high gain are required. It has a frequency range of 240 MHz to 400 MHz.
- AV 2011 is a foldable, high gain, UHF SATCOM antenna designed to withstand wind loading in excess of 80 miles per hour. This high performance antenna can be set up and deployed in less than 3 minutes using arctic gloves. The AV 2011 antenna system is directly compatible with AN/PSC-3, AN/WSC-3, URC-110, HST-4A, LST-5B, AN/PSC-5, AN/PSC-117 or equivalent ground, shelter or manpack communication systems. It has a range of 240 to 318 MHz.
- Near vertical incidence skywave is an antenna with a very high radiation angle, approaching or reaching 90 degrees and used to establish reliable communications over a radius of 0 to 300 miles. This antenna was used in World War II and again in Vietnam to provide tactical communications under various topographic conditions.
- AT-197 antenna, discone, is intended for use as an antenna for a ground radio transmitter and receiver such as the AN/GRC-27, AN/GRC-29, and AN/TRC-32 for communication with aircraft equipped with UHF command radio sets and such ground UHF stations as necessary in the UHF terminal area. It is designed to operate at an impedance of 50 ohms. Its frequency range is 225 to 500 MHz.

### System Hardware Capabilities

B-31. The ADAM cell is comprised of the major end items which are described in this section. Also discussed are the equipment capabilities.

### *Air Defense System Integrator*

B-32. The ADSI provides interoperability with multiple data links (TADIL A, B, J, LAN J, SATCOM J, and IBS/TBS/TRAP) to provide joint ADA SA and intelligence data to the BCT. The MIDS, JTT, and AN/PSC-5 provide communications support to the ADSI. A multilink C<sup>2</sup> system, the ADSI provides operators and commanders from theater level down to the ADAM cell a joint, integrated air picture. To accomplish this, it physically ties into the AMDWS and TAIS and provides routing capabilities to support TADIL A, B, and J; JTIDS; the FDL, North Atlantic Treaty Organization (NATO) Link 1; Army tactical data link 1 (ATDL1); and the IBS. The IBS offers the crew the ability to receive intelligence and tactical information to include space-based intelligence. The ADSI plays a vital role in the functioning of the AMDWS and TAIS because it feeds tracking and other tactical information it receives via its links to the AMDWS and TAIS processors. Without ADSI input, AMDWS and TAIS cannot perform their jobs of providing AD early warning and SA.

B-33. The ADSI provides three functions to the third dimension air picture. First, it provides routing capabilities to support TADIL A, B, and J. It also provides the capability to receive intelligence information from the IBS, specifically from TIBS and TDDS. It provides a set of command and control functions to the crew of the ADAM cell.

### ***Tactical Airspace Integration System***

B-34. TAIS is the Battlefield Automated System of ABCS. It revolutionizes the management of airspace and conduct of air traffic services. By providing interoperability within ABCS, standardization of software, commonality of hardware components and configurations, and the interoperability with joint coalition, civil aviation, and forces, TAIS effectively bridges the gap between technology and military doctrine for legacy, interim, and objective forces. The near-real-time integrated air and ground picture displays the airspace control order in two and three dimensions.

B-35. TAIS provides the ADAM cell the ability to manage airspace in its area of operations and the deconfliction of aerial platforms and objects operating in that airspace. It offers automated airspace C<sup>2</sup> and air traffic management and deconfliction capabilities for operators and commanders at levels above corps down to the ADAM cell at support brigades. A member of the ABCS, TAIS interfaces with the Air Force's theater battle management core system and civil and military airspace management systems and agencies. It also links with the ADSI, which feeds it tracking and tactical information. This networking, combined with automation software, allows the operator to provide the commander with a near-real-time, 3-D AC<sup>2</sup> picture of the third-dimension operational environment. The operator can also synchronize and deconflict the airspace to prevent fratricide and assist commanders in mission accomplishment.

B-36. The ADAM cell operator accomplishes these tasks from the TAIS workstation, which functions as an airspace information center. From the TAIS workstation, the operator can follow flights transiting through BCT airspace, receive and process flight advisories, issue air warnings, and provide real-time positive control of BCT airspace. For example, when the TAIS operator receives information that a BCT artillery unit has received a fire mission, he can immediately generate a 3-D AC<sup>2</sup> picture of the airspace impacted by the flight of the artillery rounds and ascertain if they will conflict with friendly aircraft transiting BCT airspace. Automation allows the operator to make this determination in seconds and reroute aircraft, if necessary, to prevent fratricide. The TAIS receives the recognized air picture through several communication links providing near-real-time SA for both friendly and enemy air activity. Visualization of four dimensions, SA, airspace deconfliction, and fratricide avoidance, TAIS receives input from the following:

- ADSI.
- AWACS TADIL-A Link.
- Theater battle management core system.
- Contingency theater air control system automated planning system.
- FAAD C<sup>2</sup>.
- TADIL-A Link.
- TADIL-B Link.
- TADIL-J Link.
- International Civil Aviation.
- Federal Aviation Administration.

B-37. TAIS will also receive a text message copy of the airspace control order from the higher Air Force Air Operations Center or the Army's Battlefield Coordination Detachment, then convert it into a graphic format and display it on the flat screen. This precludes the operator from manually inputting the airspace control measures onto the map overlays. An operation that took several man-hours to complete, now takes seconds.

### ***Forward Area Air Defense C<sup>2</sup> Workstation***

B-38. FAAD is the engagement operations piece of the ADAM cell element. FAAD collects, stores, digitally processes, and displays and disseminates real-time tactical cueing and tracking information, the

common tactical air picture, and command, control, and intelligence information to all ADA weapons. FAAD also provides the local air picture to joint and multinational forces to protect friendly aircraft and facilitate management of the air battle. Interoperability and horizontal integration is maintained with all Army air defense systems, including Patriot and THAAD. Distribution of the local air picture is with tactical and special purpose radios and includes integration with the AWACS, ABCS, and joint and multinational air and missile defense command and control systems FAAD C<sup>2</sup>, which currently support several global war on terrorism operations, including homeland defense.

B-39. A standard FAAD C<sup>2</sup> processor also provides the ADAM cell the ability to manage air defense engagements and early warning. Specifically, it provides the Army's FAAD datalink (Sentinel radar picture) and controls the air and missile defense engagement operations.

### ***Sentinel***

B-40. The Sentinel radar sensor is an asset organic to heavy divisions. It is designed to operate in all types of weather, severe ECM environments, and survive antiradiation missile attacks.

B-41. The Sentinel is essential to the mission in providing a local air picture in the BCT operations area. The ADAM cell will have access to the COP through a variety of communications and air picture linkages. However, these linkages do not provide enough detail to ensure effective management of the local ADA and Aviation assets in operation; for example, the Sentinel is essential for UAS identification.

B-42. The Sentinel alerts and/or cues Avenger and dismounted MANPADS Stinger teams of hostile and unknown aircraft (FW, RW, CMs, and UASs). It protects friendly forces from fratricide and provides air situational data to command and control centers. Sentinel track data is broadcast to ADA weapons and command posts through the FAAD C<sup>2</sup> system or, in the event a sensor node is not available, directly to the fire units over EPLRS or SINCGARS. The method of transmission is operator-selectable from the RCT during initialization.

B-43. To provide EW, the ADAM cell receives air tracks from external sources such as the Sentinel radar sensor, AWACS, Patriot, Aegis, and the joint tactical air ground station. The ADAM cell correlates those tracks and sends them to the BCT elements tactically located on the battlefield. The Sentinels receive that air track data, correlate it with their own data, and send the data to supported ADA batteries, platoons, sections, and fire units. To ensure the widest dissemination of EW, the BCT force uses both voice procedures and the ABCS 6.4 network to alert the brigade. All descending echelons repeat the EW. The ADAM cell operators verbally notify the BCT TOC of an air attack and then transmit a free-text message to all subordinate battalion TOCs, which triggers them to display the current air picture on their ABCS.

B-44. Digital warning messages from higher sources can arrive directly from the origin sensor or via networks. Additionally, digital air attack EW may originate internally within the BCT when air defense sensors are employed. If the AMDWS is configured to alert when hostile criteria tracks approach preset volumes, the AMDWS will automatically generate digital alerts. For example, when a hostile track crosses an established "Dynamite line," the AMDWS alerts the operator and generates E-500 (air strike warning) messages. When the operator clears the alert, these digital warnings are sent to addresses on the networked LAN of the brigade.

### ***Air and Missile Defense Workstation***

B-45. AMDWS is a collaborative operational environment awareness information management system that contributes to combat effectiveness by retrieving, fusing, and distributing time-sensitive information necessary to achieve decision-cycle dominance. AMDWS retrieves operational environment awareness information from many sources: joint headquarters, the ABCS network, national intelligence assets, all-source centers, and tactical and strategic sensors. AMDWS uses this information to provide an area-complete, combat-operations display that combines ground, air and space-based sensor inputs and command and staff data with automated planning tools. Distribution is accomplished over tactical and special purpose communications in near-real-time, while supporting concurrent interaction with joint C<sup>2</sup> networks, sensor sources, and ABCS.



B-46. The AMDWS system is the FO piece of the FAAD C<sup>2</sup>I network system supporting ADA battalions and brigades. AMDWS is also the foundation software platform for the ADATF planner for Patriot battalion units. The ADAM cell holds one AMDWS linked to both the EO monitor and the ADSI, where it can obtain external air tracks. At the brigade level, the digitized ADA battery CP operating in the brigade TOC will have one AMDWS and an EO monitor, along with its associated laptops, printers, and communications infrastructure.

**This page intentionally left blank.**

## Appendix C

# Training Devices and Aerial Targets

Today's highly technical air defense arsenal of systems and their operations require the best professional support of effective training programs and training devices to promote the skills, knowledge, and expertise required for maintainer and crew proficiency. This chapter describes the various training devices and aerial targets used when training with MANPADS for the SHORAD weapon systems, Patriot, THAAD, and the Sentinel radar.

### TRAINING DEVICES

C-1. Training devices for ADA systems consist of simulators, interactive mockups, virtual modeling, static equipment, and maintenance trainers.

#### AVENGER

C-2. Avenger training devices provide familiarization and training, to include live-fire exercises, to maintain crew efficiency in all aspects of SHORAD operations. Avenger personnel must be knowledgeable in both Avenger and MANPADS engagement roles. Listed below are Avenger-unique training devices:

- Avenger force-on-force trainer (FOFT).
- Avenger table-top trainer (TTT.)
- Institutional conduct of operations trainer (ICOT).
- Captive flight trainer (CFT).
- Aerial targets (pages C-10 and C-11).

#### Force-on-Force Trainer

C-3. The Avenger FOFT is an integrated laser engagement simulator used in the multiple-integrated laser engagement system (MILES) FOFT exercises. It provides simulation of missile firings, weapons effects, signature simulation, and real time target assessment. The FOFT is used for realistic training in combat training center exercises for gunners in a simulated wartime environment.

#### Table-Top Trainer

C-4. The Avenger TTT is an interactive graphics trainer with the principle features of the Avenger turret gunner station. A 17-inch monitor presents the out-of-window (canopy) view and the gunner's FLIR display. In addition, a FLIR field of view footswitch and a tactical gunner hand station provide for the gunner/machine interface.

#### Institutional Conduct of Operations Trainer

C-5. The FAAD system C<sup>2</sup>, communications, and intelligence activities ICOT is a computer-based training device used with Avenger at USAADASCH. This device trains initial entry and transition level personnel. It simulates all software operations of the C<sup>2</sup> and information systems nodes such as air battle management operations center (ABMOC), TOC, and BCP. ICOT provides sensor C<sup>2</sup> node simulations such as air tracking and bearing data, symbology, target ranges, weapon control orders and their status, air defense warnings (ADWs), fault simulations, and BIT operations, during continuous operations.

Each ICOT consists of six student stations and one instructor station. The ICOT is used for realistic training for all operators and AD officers.

### **Captive Flight Trainer**

C-6. The CFT consists of an actual Stinger missile guidance section assembly without the rocket motor and warhead and is used with the Avenger configuration only. The guidance section provides realistic training for target acquisition and tracking engagement procedures. The launch tube assembly is similar to the missile-round in weight, size, and external appearance, except the “fly-away” simulator module is mounted on the forward end of the launch tube. The CFT is designed to maintain and sustain the required training tasks to maintain operator proficiency to meet requirements at unit level.

### **SHORAD**

C-7. Listed below are the MANPADS (shoulder-fired) support trainers for shoulder-fired Stinger:

- Training set, GM, tracking head trainer (THT), M160.
- Field handling trainer (FHT).
- Stinger troop proficiency trainer (STPT).
- Improved moving target simulator (IMTS).
- Aerial targets (on pages C-10 and C-11).

### **Training Set, Guided Missile, Tracking Head Trainer**

C-8. The Stinger THT, M160, has the same seeker and general appearance as the RMP/Block1 missile-round as shown in Figure C-1. Components of the THT include the trainer battery, missile simulator, IFF simulator with interconnecting cable, and the performance indicator annunciator box. The performance indicator annunciator provides a means to maintain, evaluate, and enhance gunner proficiency by conducting on-the-spot corrections and evaluations. The THT is used to train gunners in sustainment training. The service school trains entry-level personnel. The IMTS, AN/FSQ-187, trains for varied target engagement scenarios, inside or outside the IMTS. A benefit of the THT is quality of training for operators and the reduction of ammunition expenditures. Audio indications of IFF response, gyro spin-up, and target acquisition (seeker lock-on) are features of this training equipment. Color identification consists of four, 1-inch blue squares located at each end of the THT launch tube. The THT trainer battery (noticeably taller than the BCU and rechargeable) supplies electrical power only to the trainer and has two, 1-inch blue squares located one on each side of the battery and one on each side of the battery receptacle. The trainer battery will provide at least fourteen 47-second training missions. The THT belt-pack is identified by blue squares about its waist. Argon coolant is housed in the launch tube and pressurized with argon as needed. The THT gripstock is maintained by maintenance personnel only. Stinger operators are not authorized to remove or install this gripstock. The trainer battery and IFF simulator belt-pack have blue squares located at same locations as the FHT. The THT shipping and storage container has the same outward appearance as the weapon-round container.

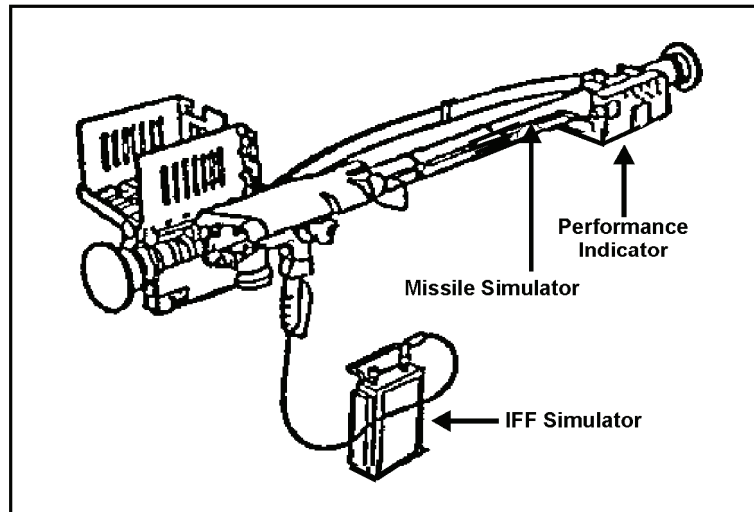

**Figure C-1. Stinger tracking head trainer**

### **Field Handling Trainer**

C-9. The Stinger FHT, M60, is assigned and used at service schools and unit level. Stinger operators use the FHT to practice manual skills of weapon handling, operation, sighting, ranging, and crew quick-reaction drills. The FHT can be used to track live aircraft or remotely piloted vehicle targets. It allows the operator to practice attaching or removing the gripstock from the launch tube, inserting and removing the battery coolant unit, and connecting and removing the IFF belt-pack interconnecting cable from the gripstock. The aforementioned components—gripstock, battery, and IFF belt-pack—are labeled as “Dummy.” There are no internal functioning components; however, the FHT and its components are the same size, weight, and external appearance as the Stinger weapon-round (36.1 pounds) with gripstock and battery installed. Audio indications of target acquisition and IFF responses are not a feature of the FHT. Trainer color code markings and associated components consist of four, 1-inch bronze squares located at each end of the launch tube and the word “Dummy” embossed along the aft section of the launch tube. Two, 1-inch bronze squares are located on the gripstock, one on each side of the battery receptacle. The belt-pack has a solid bronze band about the center with the word “Dummy” embossed.

### **Stinger Troop Proficiency Trainer**

C-10. The STPT is a computer-based device that generates digitized targets and background onto the weapon system's optics. The STPT is used in the shoulder-fired configuration only for realistic training of both active and reserve component Stinger gunners in a simulated wartime environment and eliminates the need for actual aircraft, aerial targets, firing angle considerations, and missile expenditures. The STPT is used for training entry-level personnel and to sustain training in engagement procedures and skills at unit level.

### **Improved Moving Target Simulator**

C-11. The IMTS, AN/FSQ-187, is a computer-driven indoor training facility. The IMTS, among other mission requirements, can project battlefield background scenes and moving aircraft target scenarios on a 360-degree, 40-foot diameter hemispherical dome screen to create a realistic battlefield environment. See Figure C-2. The first generation simulators were limited to the 180-degree aspect.

C-12. An instructor console located in the dome controls all scenario selections for video IR/NUV projections, sound generation, target maneuvers, and countermeasures. Up to three Stinger gunners can

be trained simultaneously. Student performance evaluations are possible during training exercises, using the instructor console. The IMTS is used to train Stinger gunners in target acquisition and engagement skills at unit, service school, and overseas command levels.



**Figure C-2. Improved moving target simulator**

## **PATRIOT**

C-13. Patriot training devices serve to train initial entry personnel and sustain unit operator and maintainer efficiency in fighting the air defense battle and maintaining the Patriot system's operational readiness. The training devices described are—

- Patriot organizational maintenance trainer (POMT).
- Patriot conduct-of-fire trainer (PCOFT).
- RS march order and emplacement trainer (MOET).
- Patriot communications system task trainer (PCSTT).
- Data link upgrade (DLU) task trainer.
- Radio frequency comparator task trainer.
- Cooling liquid electronic tube (CLET) removal and replacement (R&R) task trainer.
- Antenna element task trainer (AETT).
- Embedded trainer.
- Empty round trainer (ERT).
- Missile-round trainer (MRT).
- Patriot intermediate maintenance instructional trainer (PIMIT).

### **Patriot Organizational Maintenance Trainer**

C-14. The POMT provides a realistic static mockup of the ECS (interior and exterior) with operator consoles interchangeable to the battalion ICC configuration, and the interior and exterior of the RS shelter. The POMT consists of the active maintenance trainer simulator and the parts task trainer. It is used to train maintenance personnel in the use of display-aided maintenance (DAM), non-display-aided maintenance (non-DAM), and built-in test equipment (BITE) indicator procedures to diagnose, fault locate, remove and replace defective components, and use software routines for the RS, ECS, and ICC.

### **Patriot Conduct-of-Fire Trainer**

C-15. The PCOFT is an institutional training device for Patriot. It is a computer-driven battlefield system training device used at USAADASCH and outside continental United States (OCONUS). The PCOFT allows running Patriot tactical troop proficiency trainer (TPT) software using four enhanced WCC operator tactical trainers. The PCOFT has eight student consoles that are reproductions of the

Patriot ECS and ICC tactical system operator consoles. One instructor station is used for controlling and monitoring the student consoles. The PCOFT is used to train battalion TDs, TDAs, firing battery TCOs, and TCAs. Training is conducted on initialization procedures and AD battles, individually or paired FUs, paired battalion or netted FUs, and battalion. One PCOFT can simulate up to four battalions.

### **Radar Set March Order and Emplacement Trainer**

C-16. The Patriot RS MOET is an institutional training device. The MOET is a mock-up of the Patriot RS physical characteristics as applied to MOET tasks. The trainer consists of an RS trailer with electrical power, a rotating platform with antenna face, a shelter, and outriggers. The MOET is used to train Patriot missile crew members, operators, system mechanics, system maintenance technicians, and AD officers in march order and emplacement tasks. All march order and emplacement tasks can be trained using this device instead of the tactical system.

### **Patriot Communications System Task Trainer**

C-17. The PCSTT consists of two tactical UHF radio stacks, a patch panel, an antenna control unit, and three communications systems controls. It also has a power distribution panel to provide hands-on training in initialization, operation, and maintenance of the AN/GRC-103 UHF radio communications systems.

### **Data Link Upgrade Task Trainer**

C-18. The Patriot DLU task trainer consists of a rack of tactical DLU equipment to provide hands-on training in operation of the DLU system. Although the same basic classroom configuration as the DLU modified DLT on the ECS, the assemblies comprising the trainer are different. The DLU modification adds the SINCGARS radio AN/VRC-90 as the over-the-air communications link. A fiber-optics unit is not included due to its cost. Instead, the radio transmitters need to be loaded (dummy load) the same as the unmodified DLT. A signal is picked up and connected to the other DLU receiver via hardwire. The DLU task trainer enables the student to perform the following emplacement tasks:

- DLT module A2 energizing.
- DLT module A2 de-energizing.
- DLT power up.
- Radio AN/VRC-90 loading.
- DLT self-test.
- DLT synchronizing.
- Security unit TSEC/KY-57 loading.

### **Radio Frequency Comparator Task Trainer**

C-19. The Patriot RF comparator task trainer is a mockup of the tactical radar RF comparator and consists of tactical and mockup battery replaceable units (BRUs). The following is a list of the removal and replacement tasks that can be taught with the RF comparator task trainer, remove and replace—

- Radome with support and cooling (A139).
- Pressure switch (S1).
- Tube axial fan 81 or 82.
- Radome feed assembly.
- Main comparator horn assembly (A140) housing.
- Microwave device assemblies A142, A143, or A144 air duct hose assembly.

### **Cooling Liquid Electronic Tube Removal and Replacement Task Trainer**

C-20. The Patriot CLET R&R task trainer is a mockup of the right rear of the RS shelter, a simulated CLET rear door, and all associated hardware to perform R&R procedures. The CLET mockup includes four coolant hoses and two electrical cables.

### **Antenna Element Task Trainer**

C-21. The Patriot AETT is a task training device used to train the removal and insertion of the individual elements in the Patriot phased array radar antenna. The radar antenna systems group diagnostics are performed using either the ECS or the POMT. Identifying particular faulty elements is accomplished using full-scale silk screen drawings, partial scale photographs, or overhead projections of line drawings or photographs. Using one of these media in lieu of tactical equipment better fills requirements of student/instructor safety and convenience, and off-loads time from tactical equipment to training devices.

### **Embedded Trainer**

C-22. Patriot ETs are TPTs with software programs that are built into the tactical system and provide training in simulated AD battle scenarios. TDs, TCOs, TDAs, and TCAs receive sustainment training and collective training in detection, acquisition, identification, and engagement in ECM environments.

### **Empty Round Trainer**

C-23. The Patriot ERT canister is a reworked expended Patriot missile-round canister with appropriate markings. The ERT is used in the institution and units to train Patriot missile crew members in transporting, handling, and unloading procedures of expended missile-round canisters.

### **Missile-Round Trainer**

C-24. The Patriot MRT emulates a Patriot ready-round missile in size, weight, shape, and electrical connections. The MRT is used in both institutional and units to teach Patriot missile crew members handling, loading, and electrical checks without using a ready round.

### **Patriot Intermediate Maintenance Instructional Trainer**

C-25. The PIMIT is a training device used to provide intermediate maintenance level training to students in the use of diagnostic programs, adjustments, and calibration procedures. It also provides training in the use of test, measurement, and diagnostic equipment, parts location, and troubleshooting of system malfunctions.

## **TERMINAL HIGH-ALTITUDE AIR DEFENSE**

C-26. THAAD training devices are used to support new equipment training, and institutional and unit training. THAAD embedded trainer (ET) system capabilities are used to the maximum extent possible. The following devices make up THAAD's training aids, devices, simulators, and simulations (TADDS), which are described in detail in THAAD's Operational Requirements Document:

- User system operator trainer (USOT).
- Radar training laboratory (RTL).
- MOET.
- Missile-round trainer (MRT) and missile-round pallet trainer (MRPT).
- Explosive ordnance disposal trainer (EODT).
  - Practical EOD system trainer (PEST).
  - Classroom EOD system trainer (CEST).



**Training Aids, Devices, Simulators, and Simulations/Embedded Trainer Strategy**

C-27. The following paragraphs explain TADSS capabilities necessary to support Block 06 THAAD system training. It is important to note that ET capabilities are used whenever and wherever possible. Quality Soldier training is the prime consideration for determining and selecting TADSS functional requirements, per AR 350-1. See Figure C-3.

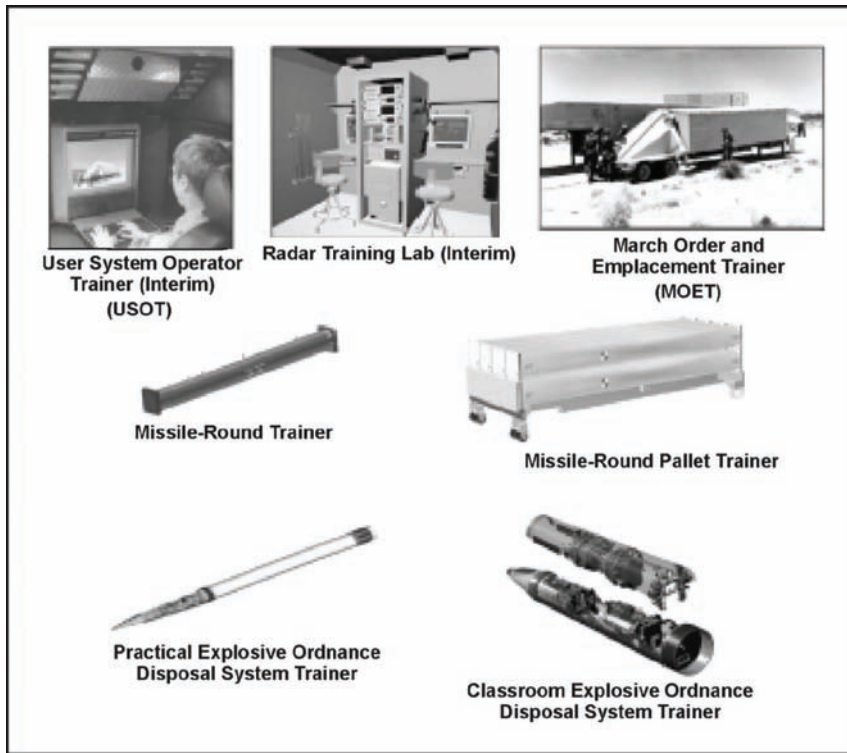

**Figure C-3. THAAD Block 06 TADSS**

***User System Operator Trainer***

C-28. The USOT (Figure C-4) will provide training on the operational use of the THAAD fire control Block 06 configuration. It will replicate TOS workstation hardware interfaces and permit training of operational functions. This design is based on user inputs and will be updated as required. The THAAD USOT is an interim training solution, and streamlined approaches may be used. Also, training effectiveness and efficiency cannot be compromised.



**Figure C-4. User system operator trainer**

#### ***Radar Training Laboratory***

C-29. The RTL provides a stand-alone radar training capability for hands-on operator training in a controlled environment. It uses hardware and software which emulates the tactical operations environment of the EEU for familiarization of system operations. The RTL also provides training for the operator who sits at the EEU enhanced operator terminal console and allows operators to perform state and mode transition.

#### ***March Order and Emplacement Trainer***

C-30. The purpose of this device is to train THAAD personnel to march order and emplace the THAAD radar. It is used in conjunction with the HEMTT tractor for training. The MOET consists of the antenna element (AE), PPU, CEU, and EEU. These components are described in the following paragraphs:

- AE: The trainer replicates the appearance and size of the AE. The simulator is used to train Soldiers in the actual road march, march order, and emplacement procedures. It is used to train the Soldiers in the proper connection of the electrical and cooling lines to the CEU and signal data lines to the EEU.
- PPU: The trainer replicates the appearance and size of the PPU. The simulator is used to train Soldiers in the actual road march, march order, and emplacement procedures. The PPU also trains the Soldiers in the proper connection of the electrical lines to the CEU.
- CEU: The trainer replicates the appearance and size of the CEU. The simulator is used to train Soldiers in the actual road march, march order, and emplacement procedures. It trains Soldiers in the proper connection of the electrical and cooling lines to the AE.
- EEU: The trainer replicates the appearance and size of the EEU. The simulator is used to train Soldiers in the actual road march, march order, and emplacement procedures. It trains Soldiers in the proper connection of the electrical, signal, and data lines to the AE.

#### ***Missile-Round Trainer***

C-31. The MRT consists of two separate configurations—the missile-round pallet trainer (MRPT) and the MRT. The purpose of the MRPT and the MRT is to train operators handling procedures of the THAAD missile at the institutional and unit levels. Both configurations are used in conjunction with the THAAD launcher for training. The MRPT and MRT will simulate weight, balance, and physical characteristics of the missile, missile loading/reloading procedures, hangfire/misfire procedures, missile handling, and transport procedures.

### ***Explosive Ordnance Disposal Trainer***

C-32. The purpose of this device is to train explosive ordnance disposal (EOD) personnel to recognize inherent hazards associated with the components of missile and practice EOD handling procedures. There are two separate EOD trainers. They are the PEST and the CEST. The PEST is a full-scale inert model of the production THAAD missile system and canister. The CEST is a half-scale inert model of the production THAAD missile and canister that has a cutaway of the areas containing explosive, hazardous, and classified components.

### **Embedded Training**

C-33. Unit sustainment training is accomplished through the use of an embedded TPT capability within the THAAD system. The software simulates operational tactical battlefield information and provides training to support both EO and FO procedures. The TPT allows operators, commanders, and staff personnel to maintain proficiency in the tactical decision-making processes and console operations. During ET, operators interact with the system in the same manner as they would under actual combat conditions. Training may be conducted within a single battery, battalion, or concurrently with other THAAD batteries and battalions to support joint and combined training.

### **SENTINEL SENSOR RADAR**

C-34. The Sentinel sensor radar is not a training device, but is required when Sentinel training devices listed below are used:

- Sentinel TPT.
- Sentinel institutional maintenance trainer (SIMT).
- Sentinel training system (STS).
- Aerial targets (on pages C-10 and C-11).

### **Sentinel Troop Proficiency Trainer**

C-35. The Sentinel TPT is embedded into, and used with, the actual Sentinel equipment. The Sentinel TPT displays incoming and outgoing information that stimulates operator procedural actions. This provides real time, free play interactive simulation that is representative of initialization, BIT/BITE operation and evaluation of data/error messages. The Sentinel TPT provides reports of operator actions and summary reports used to determine if operator performance meets the required standards for proficiency.

### **Sentinel Institutional Maintenance Trainer**

C-36. The SIMT is a 3-D trainer used for maintenance training. It is an institutional trainer consisting of an instructor console and four student stations. The instructor console initializes, controls, and monitors any combination of training stations. The SIMT is capable of training at least 100 different maintenance tasks.

### **Sentinel Training System**

C-37. The STS is capable of training students to operate the Sentinel system. The STS simulates the functional, physical operations, and characteristics of the system. The instructor operator station (IOS) has the capability to interface with, and provide up to, eight student stations with operator level scenario training associated with the Sentinel. The IOS also has the capability to select individual student stations and perform different task levels depending on the student progression.

## **AERIAL TARGETS**

C-38. Aerial targets are used to familiarize and qualify crewmen during gunnery training and system qualifications. Normally, all AD live-fire training is conducted using high-performance unmanned

aerial targets. These targets must be capable of simulating combat aircraft characteristics and require the AD weapon system to use its maximum capability. Numerous types of aerial targets, operated by troop units or furnished and operated by contract personnel, are available for AD service practice. Three categories of aerial targets (drone, towed, and ballistic) are described in Tables C-1 through C-3.

**Table C-1. Drone targets**

	<i>Description</i>	<i>Characteristics</i>	<i>Augmentation</i>
<b><i>MQM-107 Streaker</i></b>	Subscale: Subsonic FW	<ul style="list-style-type: none"> <li>• Speed: 250 to 500 kts.</li> <li>• Altitude: 50 to 40,000 ft.</li> <li>• Flight time: 60 minutes.</li> <li>• Guidance: command.</li> </ul>	Formation flights are possible depending on— <ul style="list-style-type: none"> <li>• Range availability.</li> <li>• Scoring capability.</li> </ul>
<b><i>BQM-34 Firebee</i></b>	Subscale: Subsonic FW	<ul style="list-style-type: none"> <li>• Speed: 220 to 550 kts.</li> <li>• Altitude: 100 to 55,000 ft.</li> <li>• Flight time: 60 min.</li> <li>• Guidance: command.</li> </ul>	Formation flights are possible depending on— <ul style="list-style-type: none"> <li>• Range availability.</li> <li>• Scoring capability.</li> </ul>
<b><i>QUH-1 Huey</i></b>	Full-scale, remotely-piloted, RW aircraft.	<ul style="list-style-type: none"> <li>• Speed: Hover at 0 to 100 kts.</li> <li>• Altitude: 50 to 10,000 ft.</li> <li>• Flight time: 90 min.</li> </ul>	<ul style="list-style-type: none"> <li>• IR flare.</li> <li>• Dispenser capable with ECMs.</li> </ul>

**Table C-2. Towed targets**

	<i>Description</i>	<i>Characteristics</i>	<i>Augmentation</i>
<b><i>Aerial Gunnery Towed Target</i></b>	<ul style="list-style-type: none"> <li>• 48 in long.</li> <li>• 7 in diameter.</li> <li>• Towed by a 2-ft by 12-ft multistream banner.</li> </ul>	Towing provides 1 sq m RCS in I-band coverage.	<ul style="list-style-type: none"> <li>• Bullet-counter scoring.</li> <li>• Tow-capable by MQM-107 or BQM-34.</li> </ul>
<b><i>TRX-4A Radar Tow Bee</i></b>	<ul style="list-style-type: none"> <li>• 99 in long.</li> <li>• 9 in diameter.</li> </ul>	<ul style="list-style-type: none"> <li>• Towed from 8,000-ft tow line.</li> <li>• Provides an 8 sq ft RCS in the X-Band.</li> </ul>	Tow-capable by MQM-107 or BQM-34.

**Table C-3. Ballistic target**

	<i>Description</i>	<i>Characteristics</i>	<i>Augmentation</i>
<b>Lance Missile</b>	<ul style="list-style-type: none"> <li>• Contractor-operated only.</li> <li>• Obsolete surface-to-surface tactical missile.</li> <li>• Emulates SCUD's B &amp; C.</li> </ul>	<ul style="list-style-type: none"> <li>• Speed: .88 to 3.6 mach</li> <li>• Altitude: 7,000 to 141,400 ft</li> <li>• Range: 130 km</li> <li>• Guidance: inertial guidance and control</li> <li>• Track-mounted or towed</li> </ul>	Telemetry; hit indicator.

**This page intentionally left blank.**

# Glossary

## Section 1 — Acronyms and Abbreviations

<b>AC<sup>2</sup></b>	Airspace Command and Control
<b>ABCS</b>	Army Battle Command System
<b>ABL</b>	airborne laser
<b>ABMOC</b>	Air Battle Management Operations Center
<b>ABT</b>	air-breathing threat
<b>ACUS</b>	area common user system
<b>AD</b>	air defense
<b>ADA</b>	air defense artillery
<b>ADAM</b>	air defense and airspace management
<b>ADATF</b>	air defense artillery defense task force
<b>ADSI</b>	air defense system integrator
<b>ADW</b>	air defense warning
<b>AE</b>	antenna element
<b>AETT</b>	antenna element task trainer
<b>AEU</b>	antenna equipment unit
<b>AFCC</b>	Avenger fire control computer
<b>AMD</b>	air and missile defense
<b>AMDWS</b>	air and missile defense workstation
<b>AMG</b>	antenna mast group
<b>ANCD</b>	automated network control device
<b>ASM</b>	air-to-surface missile
<b>ASV</b>	antenna support vehicle
<b>ATG</b>	antenna-transceiver group
<b>AVT</b>	automatic video tracker
<b>AWACS</b>	Airborne Warning and Control System
<b>BAE</b>	Brigade Aviation Element
<b>BALUN</b>	balanced/unbalanced
<b>BCP</b>	battery command post
<b>BCT</b>	brigade combat team
<b>BCU</b>	battery coolant unit
<b>BFSB</b>	Battlefield Surveillance Brigade
<b>BIT</b>	built-in test
<b>BITE</b>	built-in test equipment
<b>BLOS</b>	below line of sight
<b>BM</b>	ballistic missile
<b>BMD</b>	ballistic missile defense
<b>BMDS</b>	ballistic missile defense system

<b>BRU</b>	battery replaceable unit
<b>BSC</b>	battery support center
<b>btry</b>	Battery
<b>C<sup>2</sup></b>	command and control
<b>CAU</b>	crew access unit
<b>CBRN</b>	chemical, biological, radiological, and nuclear
<b>ccw</b>	Counterclockwise
<b>CDT</b>	computer display terminal
<b>CEM</b>	carrier electronics module
<b>CEST</b>	classroom explosive ordnance disposal system trainer
<b>CEU</b>	cooling equipment unit
<b>CFT</b>	captive flight trainer
<b>CLET</b>	cooling liquid electronic tube
<b>CM</b>	cruise missile
<b>COA</b>	course of action
<b>COMSEC</b>	communications security
<b>COP</b>	common operational picture
<b>COTS</b>	commercial off-the-shelf
<b>CP</b>	command post
<b>CPP</b>	command post platform
<b>CRG</b>	communications relay group
<b>CSB</b>	Combat Support Brigade
<b>CSV</b>	cable support vehicle
<b>CTT-H</b>	commander's tactical terminal-hybrid
<b>CVC</b>	combat vehicle crewman
<b>cw</b>	Clockwise
<b>DACS</b>	divert attitude control system
<b>DAGR</b>	defense advanced global positioning system receiver
<b>DAM</b>	display-aided maintenance
<b>dB</b>	Decibel
<b>DLT</b>	data link terminal
<b>DLU</b>	data link upgrade
<b>DSP</b>	Defense Satellite Program (acquisition sensor)
<b>ECCM</b>	electronic counter-countermeasures
<b>ECM</b>	electronic countermeasures
<b>ECS</b>	engagement control station
<b>ECU</b>	environmental control unit
<b>EEU</b>	electronic equipment unit
<b>ELES</b>	enhanced launcher electronics system
<b>EMP</b>	electromagnetic pulse
<b>endo</b>	Endoatmosphere



---

<b>EO</b>	engagement operations
<b>EOD</b>	explosive ordnance disposal
<b>EODT</b>	explosive ordnance disposal trainer
<b>EPLRS</b>	enhanced position location reporting system
<b>EPP</b>	electric power plant
<b>EPU</b>	electric power unit
<b>ERT</b>	empty round trainer
<b>ET</b>	embedded trainer
<b>exo</b>	Exoatmosphere
<b>FAAD</b>	forward area air defense
<b>FCC</b>	fire coordination center
<b>FDL</b>	FAAD data link
<b>FHT</b>	field handling trainer
<b>FLIR</b>	forward-looking infrared
<b>FM</b>	field manual; frequency modulation
<b>FO</b>	force operations
<b>FOFT</b>	force-on-force trainer
<b>FOL</b>	fiber optic link
<b>ft</b>	Foot
<b>FU</b>	fire unit
<b>FW</b>	fixed wing
<b>gal</b>	Gallon
<b>GEM</b>	guidance-enhanced missile
<b>GFE</b>	government-furnished equipment
<b>GM</b>	guided missile
<b>GMD</b>	ground-based midcourse defense
<b>GMT</b>	guided missile transporter
<b>GPFU</b>	gas particulate filter unit
<b>GPS</b>	global positioning system
<b>HBCT</b>	Heavy Brigade Combat Team
<b>HEMTT</b>	heavy expanded mobility tactical truck
<b>HMMWV</b>	high-mobility multipurpose wheeled vehicle
<b>hr</b>	Hour
<b>HSI</b>	heat-sensitive indicator
<b>HTU</b>	handheld terminal unit
<b>Hz</b>	Hertz
<b>IBCT</b>	Infantry Brigade Combat Team
<b>IBS</b>	Integrated Broadcast System
<b>ICBM</b>	intercontinental ballistic missile
<b>ICC</b>	information and coordination central
<b>ICOT</b>	institutional conduct of operations trainer

<b>ICSS</b>	interim contractor support system
<b>IFF</b>	identification, friend or foe
<b>IMTS</b>	improved moving target simulator
<b>in</b>	Inch
<b>IOS</b>	instructor operator station
<b>IR</b>	Infrared
<b>IRCM</b>	infrared countermeasures
<b>ISR</b>	intelligence, surveillance, and reconnaissance
<b>JDN</b>	joint data network
<b>JECN</b>	joint engagement coordination network
<b>JIM</b>	joint, interagency, and multinational
<b>JMMN</b>	joint mission management network
<b>JTIDS</b>	Joint Tactical Information Distribution System
<b>JTT</b>	joint tactical terminal
<b>kg</b>	Kilogram
<b>kHz</b>	Kilohertz
<b>km</b>	Kilometer
<b>kts</b>	Knots
<b>kw</b>	Kilowatt
<b>LAN</b>	local area network
<b>LCS</b>	launch control station
<b>LEM</b>	launcher electronics module
<b>LHS</b>	load handling system
<b>LOS</b>	line of sight
<b>LRF</b>	laser range finder
<b>LRPT</b>	large repair parts transporter
<b>LS</b>	launching station
<b>LSDU</b>	launching station diagnostic unit
<b>LTDA</b>	lower-tier defended area
<b>m</b>	Meter
<b>MANPADS</b>	man-portable air defense system
<b>MC</b>	maintenance center
<b>MCPS</b>	Mobile Command Post System
<b>ME</b>	Maneuver Enhancement
<b>METT-TC</b>	mission, enemy, terrain and weather, troops and support available, time available, civil considerations
<b>MHz</b>	Megahertz
<b>MIDS</b>	Multifunction Information Distribution System
<b>MILES</b>	multiple-integrated laser engagement system
<b>min</b>	Minute
<b>mm</b>	Millimeter

---

<b>MOET</b>	march order and emplacement trainer
<b>MOTS</b>	military off-the-shelf
<b>mph</b>	miles per hour
<b>MR</b>	missile round
<b>MRBM</b>	medium-range ballistic missile
<b>MRC</b>	missile-round container
<b>MRP</b>	missile-round pallet
<b>MRPT</b>	missile-round pallet trainer
<b>MRT</b>	missile-round trainer
<b>MSE</b>	mobile subscriber equipment
<b>NATO</b>	North Atlantic Treaty Organization
<b>NPG</b>	network participation group
<b>NUV</b>	negative ultraviolet
<b>OCONUS</b>	outside continental United States
<b>PAC-3</b>	Patriot Advanced Capabilities-3
<b>PCOFT</b>	Patriot conduct-of-fire trainer
<b>PCSTT</b>	Patriot communications system task trainer
<b>PDB</b>	post deployment build
<b>PEST</b>	practical explosive ordnance disposal system trainer
<b>PIMIT</b>	Patriot intermediate maintenance instructional trainer
<b>PLGR</b>	precision lightweight GPS receiver
<b>POL</b>	petroleum, oils, and lubricants
<b>POMT</b>	Patriot organizational maintenance trainer
<b>PPU</b>	prime power unit
<b>PSE</b>	peculiar support equipment
<b>PTL</b>	primary target line
<b>QEAM</b>	quick-erect antenna mast
<b>RADC</b>	regional air defense commander
<b>RCS</b>	radar cross section
<b>RCT</b>	remote control terminal
<b>RCU</b>	remote control unit
<b>RF</b>	radio frequency
<b>RFI</b>	radio frequency interference
<b>RMP</b>	reprogrammable micro-processor
<b>R&amp;R</b>	removal and replacement
<b>RS</b>	radar set
<b>RSTA</b>	reconnaissance, surveillance, and target acquisition
<b>RTL</b>	radar training laboratory
<b>RW</b>	rotary wing
<b>RWCIU</b>	radar weapons control interface unit
<b>RWS</b>	rigid wall shelter

<b>S-2</b>	intelligence staff officer
<b>S-3</b>	operations staff officer
<b>SA</b>	situational awareness
<b>SADC</b>	sector air defense commander
<b>SATCOM</b>	satellite communications
<b>SBCT</b>	Stryker Brigade Combat Team
<b>SHORAD</b>	short-range air defense
<b>SIMT</b>	Sentinel institutional maintenance trainer
<b>SINGARS</b>	single-channel ground and airborne radio system
<b>SRBM</b>	short-range ballistic missile
<b>SRPT</b>	small repair parts transporter
<b>STANAG</b>	standardization agreement (NATO)
<b>STC</b>	sensitivity time control
<b>STE</b>	secure telephone equipment
<b>STPT</b>	Stinger troop proficiency trainer
<b>STS</b>	Sentinel training system
<b>SVML</b>	standard vehicle-mounted launcher
<b>TAC</b>	tactical (command post)
<b>TADIL</b>	tactical digital information link
<b>TADSS</b>	training aids, devices, simulators, and simulations
<b>TAIS</b>	Tactical Airspace Integration System
<b>TBM</b>	tactical ballistic missile
<b>TCA</b>	tactical control assistant
<b>TCO</b>	tactical control officer
<b>TCS</b>	tactical command system
<b>TD</b>	tactical director
<b>TDA</b>	tactical director assistant
<b>TDDS</b>	Tactical Data Distribution System
<b>TF</b>	task force
<b>TFCC</b>	THAAD fire control and communications
<b>THAAD</b>	terminal high-altitude air defense
<b>3-D</b>	three-dimensional
<b>THT</b>	tracking head trainer
<b>TIBS</b>	tactical information broadcast service
<b>TM</b>	theater missile; technical manual
<b>TOC</b>	tactical operations center
<b>TOE</b>	table(s) of organization and equipment
<b>TOS</b>	tactical operations station
<b>TPT</b>	troop proficiency trainer
<b>TSEC</b>	transmission security
<b>TSG</b>	tactical station group

<b>TTT</b>	table-top trainer
<b>TVM</b>	track via missile
<b>UA</b>	unmanned aircraft
<b>UAS</b>	unmanned aircraft system
<b>UHF</b>	ultrahigh frequency
<b>VAC</b>	volts, alternating current
<b>VHF</b>	very high frequency
<b>WAN</b>	wide area network
<b>WCC</b>	weapons control computer
<b>WRC</b>	weapon-round container

## Section II — Terms

### **air-breathing threat**

A platform which uses atmospheric effects to create lift or guidance to achieve flight. This term is synonymous with nonballistic track, target, or threat.

### **area of operations**

An operational area defined by the joint force commander for land and naval forces. Area of operations do not typically encompass the entire operational area of the joint force commander, but should be large enough for component commanders to accomplish their missions and protect their forces. For Army forces, it is a geographical area, including the airspace above, usually defined by lateral, forward, and rear boundaries assigned to a commander, by a higher commander, in which he has responsibility and the authority to conduct military operations.

### **ballistic missile**

Any missile that does not rely upon aerodynamic surfaces to produce lift and consequently follows a ballistic trajectory when thrust is terminated.

### **command and control**

The exercise of authority and direction by a properly designated commander over assigned and attached forces in the accomplishment of a mission. Commanders exercise command and control through a command and control system.

### **command and control system**

The arrangement of personnel, information management, procedures, and equipment and facilities essential for the commander to conduct operations.

### **command post**

A unit's headquarters where the commander and staff perform their activities.

### **common operational picture**

An operational picture tailored to the user's requirements based on common data and information shared by more than one command.

### **defense design**

A sub-process of defense planning in which a specific laydown of friendly elements, along with initializing and controlling parameters, is developed to achieve the commander's desired outcome.

### **defense planning**

The holistic process by which the commander envisions a desired outcome, lays out effective ways of achieving it, and communicates to his subordinates his vision, intent, and decisions, focusing on the

results he expects to achieve.

### **fire unit**

The smallest group of personnel and equipment capable of conducting a complete engagement from detection through destruction. In Patriot and THAAD, a firing battery is a fire unit, although a fire unit less than a firing battery can be deployed and employed (for example, as a minimal engagement capability package during early entry operations). An Avenger platform satisfies the term “fire unit” by itself.

### **operational environment**

A composite of the conditions, circumstances, and influences that affect the employment of military forces and bear on the decisions of the unit commander.

### **Organic**

Assigned to and forming an essential part of a military organization. For AMD, the application includes attachment to a military organization as a result of task force tailoring using METT-TC.

### **Planning**

The process by which commanders (and staff if available) translate the commander’s visualization into a specific course of action for preparation and execution, focusing on the **expected results**.

### **Situational awareness**

The ability to have accurate and timely information of friendly, enemy, neutral, and noncombatant locations and activities. This information is essential for developing the common operational picture and provides the basis for situational understanding.

### **Situational understanding**

The product of applying analysis and judgment to the common operational picture to draw METT-TC conclusions.

### **task force**

A temporary grouping of units, under one commander, formed for the purpose of carrying out a specific operation or mission. In the context of this concept of operations document, a task force is a deployable ADA force that has been tailored per METT-TC to achieve its assigned mission.

# References

DA forms are available on the Army Publishing Directorate web site ([www.apd.army.mil](http://www.apd.army.mil)).

## REQUIRED PUBLICATIONS

These sources must be available to the intended users of this publication.

None

## RELATED PUBLICATIONS

These sources contain relevant supplemental information. Most Army doctrinal publications are available on-line at <http://www.usapa.army.mil/>. Most joint publications are available on-line at [http://www.dtic.mil/doctrine/s\\_index.html](http://www.dtic.mil/doctrine/s_index.html).

## ARMY PUBLICATIONS

TB 380-41, *Security: Procedures for Safeguarding, Accounting, and Supply Control of COMSEC Material*, 15 March 2006

## SOURCES USED

These are the sources quoted or paraphrased in this publication.

## ARMY PUBLICATIONS

- AR 350-1, *Army Training and Leader Development*, 3 August 2007
- FM 3-0, *Operations*, 14 June 2001
- FM 3-01.48, *Divisional Air and Missile Defense Sentinel Platoon Operations*, 12 December 2003
- FM 3-01.85, *Patriot Battalion and Battery Operations*, 28 April 2006
- FM 3-01.87, *Patriot Tactics, Techniques, and Procedures*, 14 August 2006
- FM 3-01.94, *Army Air and Missile Defense Command Operations*, 08 April 2005
- FM 34-130, *Intelligence Preparation of the Battlefield*, 08 July 1994
- FM 44-18-1, *Stinger Team Operations*, 31 December 1984
- FM 44-100, *US Army Air and Missile Defense Operations*, 15 June 2000
- FM 100-12, *Army Theater Missile Defense Operations*, 31 March 2000
- FMI 3-01.9, *Air and Missile Defense Battalion Operations*, 12 November 2005
- FMI 3-01.50, *Air Defense and Airspace Management Cell Operations*, 27 February 2007
- STP 44-14S14-SM-TG, *Soldier's Manual and Trainer's Guide, MOS 14S, Avenger Crew Member, Skill Levels 1, 2, 3, and 4*, 1 September 2004
- TM 9-1425-433-10, *Operator's Manual for Guided Missile Battery Control Central, Vehicle-Mounted AN/TWQ-1 Avenger Air Defense Weapon System (NSN 1430-01-378-6963) (EIC: NWC) (1430-01-409-1965) (EIC: NWB)*, 6 October 1997 (Change 3, 07 May 2001)
- TM 9-1430-741-10, *Operator's Manual for Sentinel, AN/MPQ-64 (NSN 1430-01-420-8077)*, 21 April 2006
- TM 9-2320-280-10, *Operator's Manual for Truck, Utility, Cargo/Troop Carrier, 1 1/4-Ton 4X4, M998 (NSN 2320-01-107-7155) (EIC: BBD); M998A1 (2320-01-371-9577) (EIC:BBN); Truck, Utility: Cargo/Troop Carrier, 1-1/4 ton, 4X4, W/Winch, M1038 (2320-01-107-7156) (EIC: BBE); M1038A1 (2320-01-371-9578) (EIC: BBP); Truck, Utility: Heavy Variant, 4X4, M1097 (2320-01-346-9317) (EIC: BBM); M1097A1 (2320-01-371-9583) (EIC: BBU); M1097A2 (2320-01-380-8604) (EIC: BB6); Truck, Utility: Tow Carrier, Armored, 1-1/4 Ton, 4X4, M966 (2320-01-107-7153) (EIC: BBC); M966A1 (2320-01-372-3932) (EIC: BBX);*

- Truck, Utility: Tow Carrier, Armored, 1-1/4 TON, 4X4, W/Winch, M1036 (2320-01-107-7154) (EIC: BBH); Truck, Utility: Tow Carrier, W/Supplemental Armor, 1-1/4 Ton, 4X4, M1045 (2320-01-146-7191); M1045A1 (2320-01-371-9580) (EIC: BBR); M1045A2 (2320-01-380-8229) (EIC: BB5); Truck, Utility: Tow Carrier, W/Supplemental Armor, 1-1/4 Ton, 4X4, W/Winch, M1046 (2320-01-146-7188); M1046A1 (2320-01-371-9582) (EIC: BBT); Truck, Utility: Armament Carrier, Armored, 1-1/4 Ton, 4X4, M1025 (2320-01-128-9551) (EIC: BBF); M1025A1 (2320-01-371-9584) (EIC: BBV); M1025A2 (2320-01-380-8233) (EIC: BB3); Truck, Utility: Armament Carrier, Armored, 1-1/4 Ton, 4X4, W/Winch, M1026 (2320-01-128-9552) (EIC: BBG); M1026A1 (2320-01-371-9579) (EIC: BBQ); Truck, Utility: Armament Carrier, W/Supplemental Armor, 1-1/4 Ton, 4X4, M1043 (2320-01-146-7190); M1043A1 (2320-01-372-3933); M1043A2 (2320-01-380-8213) (EIC: BB4); Truck, Utility: Armament Carrier, W/Supplemental Armor, 1-1/4 TON, 4X4, W/Winch, M1044 (2320-01-146-7189); M1044A1 (2320-01-371-9581); Truck, Utility: S250 Shelter Carrier, 4X4, M1037 (2320-01-146-7193) (EIC: BBK); Truck, Utility: S250 Shelter Carrier, 4X4, W/Winch, M1042 (2320-01-146-7187); Truck, Ambulance, 2-Litter, Armored, 4X4, M996 (2310-01-111-2275) (EIC: BBB); M996A1 (2310-01-372-3935) (EIC: BB2); TRuck, Ambulance, 4-Litter, Armored, 4X4, M997 (2310-01-111-2274) (EIC: BBA); M997A1 (2310-01-372-3934) (EIC: BBZ); M997A2 (2310-01-380-8225) (EIC: BB8); Truck, Ambulance, 2-Litter, Soft Top, 4X4, M1035 (2310-01-146-7194); M1035A1 (2310-01-371-9585) (EIC: BBW); M1035A2 (2310-01-380-8290) (EIC: BB9), 31 January 1996 (Change 3, 15 July 2004)*
- TM 9-6115-642-10, *Operator's Manual for Generator Set Skid-Mounted, Tactical Quiet, 10-kw, 60 and 400 Hz MEP-803A (60 Hz) (NSN 6115-01-275-5061) MEP-813A (400 Hz) (6115-01-274-7392)*, 30 December 1992 (Change 2, 30 October 1996)
- TM 11-5820-890-10-8, *Operator's Manual for SINCGARS Ground Combat Net Radio, ICOM Manpack Radio, AN/PRC-119A (NSN 5820-01-267-9482) (EIC: L2Q), Short Range Vehicular Radio AN/VRC-87A (5820-01-267-9480) (EIC: L22), Short Range Vehicular Radio with Single Radio Mount AN/VRC-87C (5820-01-304-2045) (EIC: GDC), Short Range Vehicular Radio with Dismount AN/VRC-88A (5820-01-267-9481) (EIC: L23), Short Range/Long Range Vehicular Radio AN/VRC-89A (5820-01-267-9479) (EIC: L24), Long Range Vehicular Radio AN/VRC-90A (5820-01-268-5105) (EIC: L25), Short Range/Long Range Vehicular Radio with Dismount AN/VRC-91A (5820-01-267-9478) (EIC: L26), Short Range/Long Range Vehicular Radio AN/VRC-92A (5820-01-267-9477) (EIC: L27) used with Automated Net Control Device (ANCD) (AN/CYZ-10) Precision Lightweight GPS Receiver (PLGR) (AN/PSN-11) Secure Telephone Unit (STU) Frequency Hopping Multiplexer (FHMUX)*, 1 December 1998

## INTERNATIONAL STANDARDIZATION AGREEMENTS

- STANAG 3700, *Joint Air and Space Operations Doctrine—AJP-3.3*, Edition 6, 10 October 2000
- STANAG 3805, *Doctrine for Joint Airspace Control—AJP-3.3.5(A)*, Edition 8, 5 April 2006
- STANAG 3880, *Counter Air—AJP-3.3.1(A)*, Edition 5, 5 April 2006

## JOINT AND MULTISERVICE PUBLICATIONS

- CJCSM 6120.01D, *Joint Multi-Tactical Data Link Operating Procedures (JMTOP)*, 22 November 2005
- JP 1-02, *Department of Defense Dictionary of Military Terms and Associated Terms*, 12 April 2001 (as amended through 12 July 2007)
- JP 3-0, *Joint Operations*, 17 September 2006
- JP 3-01, *Countering Air and Missile Threats*, 05 February 2007
- JP 5-0, *Joint Operation Planning*, 26 December 2006



**PRESCRIBED FORMS**

None

**REFERENCED FORMS**

DA Form 2028, *Recommended Changes to Publications and Blank Forms*

**This page intentionally left blank.**

# Index

## A

ADA composite battalion, 4-1 through 4-8  
aerial targets, viii, C-1, C-2, C-9 through C-11  
air and missile defense (AMD), v, vii, viii, 2-1, 2-2, 4-8, B-1  
air and missile defense workstation (AMDWS), 2-3, 2-5, B-2, B-5, B-10, B-12, B-13  
air defense artillery (ADA), v, vii, viii, 1-1, 1-13, 2-1, 3-3, 3-4, A-1, C-1  
air defense artillery (ADA) composite battalion, 4-1 through 4-8  
air defense artillery fire control officer (ADAFCO), 4-1, 4-8  
air defense artillery task force (ADATF), 4-4  
communications, 4-6 through 4-8  
operations, 4-4, 4-5  
air defense system integrator (ADSI), B-6, B-10, B-11, B-13  
Airborne Warning and Control System (AWACS), 4-8, B-11, B-12  
air-breathing threat (ABT), 2-9, 2-10  
air-to-surface missile (ASM), 2-2, 4-4  
antenna mast group (AMG), 2-8, 2-11  
Airspace Command and Control (AC<sup>2</sup>), vii, A-3, B-1, B-2, B-11  
Army Battle Command System (ABCS), B-2, B-3, B-7, B-11 through B-13  
Avenger, viii, 1-1 through 1-4, 4-1, 4-3 through 4-6, A-1, B-12, C-1, C-2

## B

ballistic missile (BM), vii, viii, 3-1, 3-2, 3-3, 4-1  
Ballistic Missile Defense System (BMDS), 3-1, 3-2, 3-4

battery command post (BCP), 2-5, 2-6, C-3  
battery coolant unit (BCU), 1-2, 1-4 through 1-6, 1-8, 1-9, 1-12, C-2  
battery support center (BSC), 3-7  
Brigade Aviation Element (BAE), B-1 through B-4  
built-in test (BIT), 1-4, C-2, C-9  
built-in test equipment (BITE), C-4, C-9

## C

captive flight trainer, C-2  
classroom explosive ordnance disposal system trainer (CEST), C-6 through C-8  
common operational picture (COP), 4-8, B-2, B-3, B-12  
communications  
ACUS, 4-7  
ADSI, B-3, B-5, B-7, B-10 through B-12  
AM 1780/VRC, 1-2  
AMG, 2-8, 2-11  
AN/PRC-117, B-6, B-7  
AN/PSN-11 PLGR, 1-2  
AN/PSQ-6 EPLRS, 1-2  
AN/VRC-90, B-7  
AN/VRC-92A, SINCGARS, 1-2, 1-13, 2-4, 2-7, 4-7, A-3, B-8 through B-10, B-13, C-5  
AN/VRC-103, B-6, B-7  
AN/VRC-104, B-6, B-7  
AS-1729/VRC antenna, 1-2  
BCT TOC with ADAM cell, B-3  
C-2298/VRC control box, 1-2  
common data link interface, 2-3  
COMSEC, 4-2, B-6, B-9  
CP-1995/U SHTU, 1-2  
CRG, 2-2, 2-4, 2-8, 2-12  
commander's tactical terminal-hybrid (CTT-H), 4-8  
CVC helmet, 1-2  
DAGR, B-7  
EPLRS, 1-2, 1-13, A-3, B-6, B-7, B-9, B-13

FDL, A-3, B-3, B-10  
forward area air defense (FAAD), 1-12, A-1 through A-4, B-3, B-5, B-10 through B-12, C-3  
fire coordination center (FCC), 4-1, 4-2, 4-8  
FM, 4-6, 4-7, B-7 through B-9  
HF BLOS, B-7  
IBS, B-7  
ICC, 2-2 through 2-4, 2-8, 2-12, 4-2, 4-4, 4-6 through 4-8, C-4  
JDN, 4-6, 4-7  
JECN, 4-6, 4-7  
JMMN, 4-6, 4-7  
joint networking, B-3  
JTIDS, 4-6, A-3, B-3, B-8 through B-10  
JTT, 2-3, B-3, B-6, B-8, B-10  
LAN, B-3, B-5, B-7, B-10, B-12  
MIDS, B-6, B-7, B-8, B-10  
MSE, 4-6  
OE-254 bi-conical antenna, B-11  
RT-1439/VRC-91(A) RT, 1-2  
SATCOM, B-3, B-7, B-10, B-11  
STE, B-6, B-7, B-9  
TAC link, B-6, B-7  
tactical satellite (TACSAT), 2-3  
TADIL-J, 4-6, B-6, B-11  
TAIS, B-2, B-3, B-8, B-10, B-11  
TDDS, B-3, B-6, B-8, B-10  
TFCC, 3-3, 3-4  
TIBS, 4-8, B-3, B-6, B-8, B-10  
TOC, 2-5, 4-4, 4-5, 4-7, B-6, B-7, B-12, B-13, C-1  
UHF, 2-4, 2-8, 4-6, 4-7, B-7, B-8, B-9, B-10, C-5  
VHF LOS voice, B-7  
voice/FAX, 4-6  
WAN, B-7

communications relay group (CRG), 2-2, 2-4, 2-8, 2-12, 4-7

conduct of fire trainer, Patriot (PCOFT), C-4

cooling equipment unit (CEU), 3-6, 3-7, C-8

cruise missile (CM), vii, 1-1, 1-2, 2-7, 2-9, 2-10, 4-1, 4-4, B-12

**E**

electric power plant III (EPP III), 2-2, 2-11, 2-13

electronic equipment unit (EEU), 3-6, 3-7, C-8

engagement control station (ECS), 2-2, 2-4 through 2-8, 2-10, 2-11, 4-1, 4-3, 4-6, C-4 through C-6

enhanced launcher electronics system (ELES), 2-7

enhanced position location reporting system (EPLRS), 1-2, 1-4, A-2, A-3, B-6, B-9, B-12

**F**

FAAD data link (FDL), A-3, B-3, B-10

fiber optics, 2-7, 3-4, C-5

field handling trainer (FHT), C-2, C-3

fire coordination center (FCC), 4-1, 4-2, 4-8

fire direction center (FDC), 2-2

force-on-force trainer (FOFT), C-1

force operations (FO), 3-4, 4-7, B-12, C-8

forward-looking infrared (FLIR), 1-1, 1-3, 1-4, C-1

**G**

gas-particulate filter unit (GPFU), 2-2, 2-4

global positioning system (GPS), 1-2, B-5, B-9

gripstock

- Avenger, 1-2
- FHT, C-3
- RMP/Block, 1-6
- Stinger, 1-4 through 1-6, 1-8
- THT, C-2

ground-based midcourse defense (GMD), 3-2

guidance-enhanced missile (GEM), 2-9, 2-10

guided missile (GM), 1-5, 2-2, 2-10 through 2-12, C-2

guided missile transporter (GMT), 2-10, 2-12

**H**

handheld terminal unit (HTU), 1-4

heat-sensitive indicator (HSI), 1-9

Heavy Brigade Combat Team (HBCT), B-1 through B-4

heavy expanded mobility tactical truck (HEMTT), 2-2, 2-6, 2-7, 2-10, 2-12, 2-13, 3-4, C-8

high-mobility multipurpose wheeled vehicle (HMMWV), 1-1, 1-3, 2-5, A-1, A-3, A-4, B-5, B-7, B-10

**I**

identification, friend or foe (IFF), 1-2 through 1-12, A-1, A-2, C-2, C-3

improved moving target simulator (IMTS), C-2 through C-4

Infantry Brigade Combat Team (IBCT), B-1 through B-4

information and coordination central (ICC), 2-2 through 2-4, 2-8, 2-12, 4-2, 4-4, 4-6 through 4-8, C-4

infrared (IR), 1-5 through 1-7, C-3, C-10

institutional conduct of operations trainer (ICOT), C-1, C-2

instructor operator station (IOS), C-9

Integrated Air Defense System, 4-8

Integrated Broadcast System, B-7

intelligence, surveillance, and reconnaissance (ISR), vii, B-2, B-4

intercontinental ballistic missile (ICBM), 3-2

intermediate-range ballistic missile (IRBM), 3-1 through 3-3

**J**

joint data network (JDN), 4-6, 4-7

joint engagement coordination network (JECN), 4-6, 4-7

Joint, Interagency, and Multinational (JIM), vii, 4-1, B-1 through B-3

joint mission management network (JMMN), 4-6, 4-7

Joint Tactical Information Distribution System (JTIDS), 4-6, A-3, B-8 through B-10

joint tactical terminal (JTT), 2-3, B-3, B-6, B-8, B-10

Joint Theater Missile Defense, 3-3

**L**

large repair parts transporter (LRPT), 2-10, 2-12

laser range finder (LRF), 1-12

launch control station (LCS), 2-4, 3-4, 4-5, 4-7

launch tube assembly, 1-7, C-2

launcher

- Patriot, 2-7, 2-12, 4-3
- THAAD, 3-3 through 3-5, 4-5, C-8

launching station (LS), 2-7, 2-8, 2-11, 2-12, 4-1

launching station diagnostic unit (LSDU), 2-7

load handling system (LHS), 3-4, 3-5

local area network (LAN), B-3, B-5, B-7, B-10, B-12

lower-tier defended area (LTDA), 4-5

**M**

maintenance center, 2-10, 2-11, 2-12

man-portable air defense system (MANPADS), 1-1, 1-2, 1-4, 1-5, 1-13, A-1, B-12, C-1, C-2

- Avenger, viii, 1-1 through 1-13, 4-1, 4-3 through 4-6, A-1, B-12, C-1 through C-4
- Stinger (shoulder-fired), viii, 1-1, 1-4 through 1-13, A-1, B-12, C-2 through C-4

Maneuver Enhancement (ME), B-1, B-4

march order and emplacement trainer (MOET), C-4, C-5, C-6, C-8

medium-range ballistic missile (MRBM), 3-1, 3-3

missile

- Patriot, 2-7 through 2-10, 2-12
- Stinger, 1-4 through 1-6
- THAAD, 3-2 through 3-5

missile-round, 1-2, 1-4, 1-6, 3-3, 3-5, 3-6, C-2

missile-round container (MRC), 1-12

missile-round pallet (MRP), 3-4, 3-5

missile-round pallet trainer (MRPT), C-6, C-8

missile-round trainer (MRT), C-4, C-6, C-8

mission, enemy, terrain and weather, troops and support available, time available, civil considerations (METT-TC), 4-1, 4-4, B-2, B-3

Mobile Command Post System (MCPS), B-4

mobile subscriber equipment (MSE), 4-7

Multifunction Information Distribution System (MIDS), B-7, B-9, B-11

multiple-integrated laser engagement system (MILES), C-1

**N**

negative ultraviolet (NUV), 1-5 through 1-7, 1-9, C-3

network participation group (NPG), 4-6, 4-7

**P**

Patriot antenna element task trainer, C-4

Patriot CLET removal and replacement task trainer, C-6

Patriot communications system task trainer (PCSTT), C-4, C-5

Patriot conduct-of-fire trainer (PCOFT), C-4, C-5

Patriot data link upgrade task trainer, C-5

Patriot embedded trainer, C-6

Patriot empty round trainer, C-6

Patriot intermediate maintenance instructional trainer (PIMIT), C-6

Patriot MOET, C-5

Patriot organizational maintenance trainer (POMT), C-4

Patriot RF comparator task trainer, C-5

Patriot system, viii, 2-1 through 2-13

- antenna mast group, 2-8, 2-11
- communications, 2-1, 2-2, 2-3, 2-4, 2-5, 2-8, 4-6, 4-7
- communications system task trainer, C-5
- missiles, 2-7 through 2-12
- PAC-2, 2-7, 2-9, 2-12
- PAC-3, 2-7, 2-8, 2-10, 2-12, 4-4
- training devices, C-4 through C-6

peculiar support equipment (PSE), 3-7

practical explosive ordnance disposal system trainer (PEST), C-6, C-7

precision lightweight GPS receiver (PLGR), 1-2, A-3, B-9

prime power unit (PPU), 3-6, 3-7, C-8

**Q**

quick-erect antenna mast (QEAM), B-11

**R**

radar cross-section (RCS), 2-9, 2-10, C-10

radar set (RS) (C-4, Patriot), 2-2, 2-6, 2-10, 2-11, 4-1

radar training laboratory (RTL), C-6, C-8

radar weapons control interface unit (RWCIU), 2-4, 2-6

radio relay terminal (RRT), 2-4

receiver transmitter (RT), 1-2

reconnaissance, surveillance, and target acquisition (RSTA), viii, 1-1

regional air defense commander (RADCC), 4-8

remote control terminal (RCT), A-2, B-13

remote control unit (RCU), 1-1, 1-3, 1-4

remotely piloted vehicle target, C-3

reprogrammable microprocessor (RMP), 1-1, 1-5, 1-6, 1-8, 1-10, C-2

rigid wall shelter (RWS), B-5

**S**

satellite communications (SATCOM), B-3, B-7, B-10, B-11

sector air defense commander (SADC), 4-8

secure telephone equipment (STE), B-6, B-7, B-9

sensitivity time control (STC), 1-4

Sentinel radar, viii, 4-1, 4-3, A-1 through A-5, B-13

Sentinel institutional maintenance trainer (SIMT), C-9

Sentinel training system (STS), C-9

short-range air defense (SHORAD), viii, 1-1, 2-1, C-1, C-2

- Avenger, viii, 1-1 through 1-13, 4-1, 4-3 through 4-6, A-1, B-12, C-1 through C-4
- Stinger, viii, 1-4 through 1-13, A-1, B-12, C-2 through C-4

short-range ballistic missile (SRBM), 3-1, 3-3, 4-4, 4-5

single-channel ground and airborne radio system (SINCGARS), 1-2, 1-4, 2-4, 2-7, 4-7, A-2, B-7 through B-9, B-12, C-5

single-integrated air picture, B-1

situational awareness (SA), vii, 4-8, B-1, B-10, B-11

situational understanding (SU), vii, B-1, B-3

slew-to-cue system, 1-4

small repair parts transporter (SRPT), 2-10, 2-12

standard vehicle-mounted launcher (SVML), 1-1, 1-2

Stinger, viii, 1-4 through 1-13, A-1, B-12, C-1 through C-4

Stinger troop proficiency trainer (STPT), C-3

Stryker Brigade Combat Team (SBCT), B-1 through B-4

**T**

table-top trainer (TTT), C-1

tactical air operations center, 4-8

Tactical Airspace Integration System (TAIS), B-2, B-3, B-8, B-10, B-11

tactical ballistic missile (TBM), 2-2, 2-7, 2-9, 2-10, 3-1, 4-4, 4-5

tactical command system (TCS), 2-3, 4-2, 4-4, 4-7, 4-8

tactical control assistant (TCA), 2-5, C-5, C-6

tactical control officer (TCO), 2-5, C-5, C-6

Tactical Data Distribution System (TDDS), B-3, B-6, B-8, B-10

tactical digital informational link (TADIL) A, B, and J, 2-5, 4-6, B-6, B-7, B-8, B-10, B-11

tactical director (TD), 2-2, C-4

tactical director assistant (TDA), 2-2, C-5, C-6

tactical information broadcast service (TIBS), 4-8, B-6, B-8, B-10

tactical operations center (TOC), 2-5, 4-4, 4-5, 4-7, B-6, B-7, B-12, B-13, C-1

tactical operations station (TOS), 3-4, 4-7, C-7

tactical station group (TSG), 3-4, 4-7

targets, aerial  
ballistic, C-11

drone, C-10

towed, C-10

task force (TF), 2-1, 4-1, 4-4, 4-5, 4-7, B-12

terminal high-altitude air defense (THAAD) system, viii, 2-1, 3-1 through 3-8, 4-4 through 4-6, B-13, C-1, C-6 through C-9

THAAD fire control and communications (TFCC), 3-3, 3-4

track via missile (TVM), 2-9, 2-10

tracking head trainer (THT), C-2

training aids, devices, simulators, and simulations (TADSS), C-7 through C-9

transmission security (TSEC), 1-10, 1-11, B-9, C-5

troop proficiency trainer (TPT), C-4, C-6, C-9

turret gunner's station, 1-2, 1-3, C-1

**U**

unmanned aircraft (UA), 1-1, 1-6, 1-10, 4-4

unmanned aircraft system (UAS), vii, 1-1, 1-2, 1-6, 2-2, B-12

**W**

weapon-round container (WRC), 1-12

**FM 3-01.11**

**23 October 2007**

By Order of the Secretary of the Army:

**GEORGE W. CASEY, JR.**  
*General, United States Army*  
*Chief of Staff*

Official:



**JOYCE E. MORROW**  
*Administrative Assistant to the*  
*Secretary of the Army*  
0727501

**DISTRIBUTION:**

*Active Army, Army National Guard, and U.S. Army Reserve:* Not to be distributed: Electronic media only.

